



Hygiene · Aufbereitung

Hygiene · Instrument Reprocessing

Hygiene · Instrument Reprocessing

Hygiene · Aufbereitung

1 Machine Reprocessing / Sterilization

Maschinelle Aufbereitung / Sterilisation

2 Disinfection / RIWO-BOX

Desinfektion / RIWO-BOX

3 Reprocessing Accessories

Aufbereitungs-Zubehör

4 Detergents and Cleaning Agents

Reinigungs- und Pflegemittel

5 Anti Fogging Agents

Antibeslagmittel

6 Accessories / Rubber Seals

Zubehör / Gummidichtungen

7

8 Sterile Water Filter Unit

Sterilwasser-Filteranlage

*Reprocessing Baskets
for Standard Endoscopes*

*for machine reprocessing
and sterilization*

**Aufbereitungskörbe
für Standard-Endoskope**

für die maschinelle Aufbereitung
und Sterilisation



1

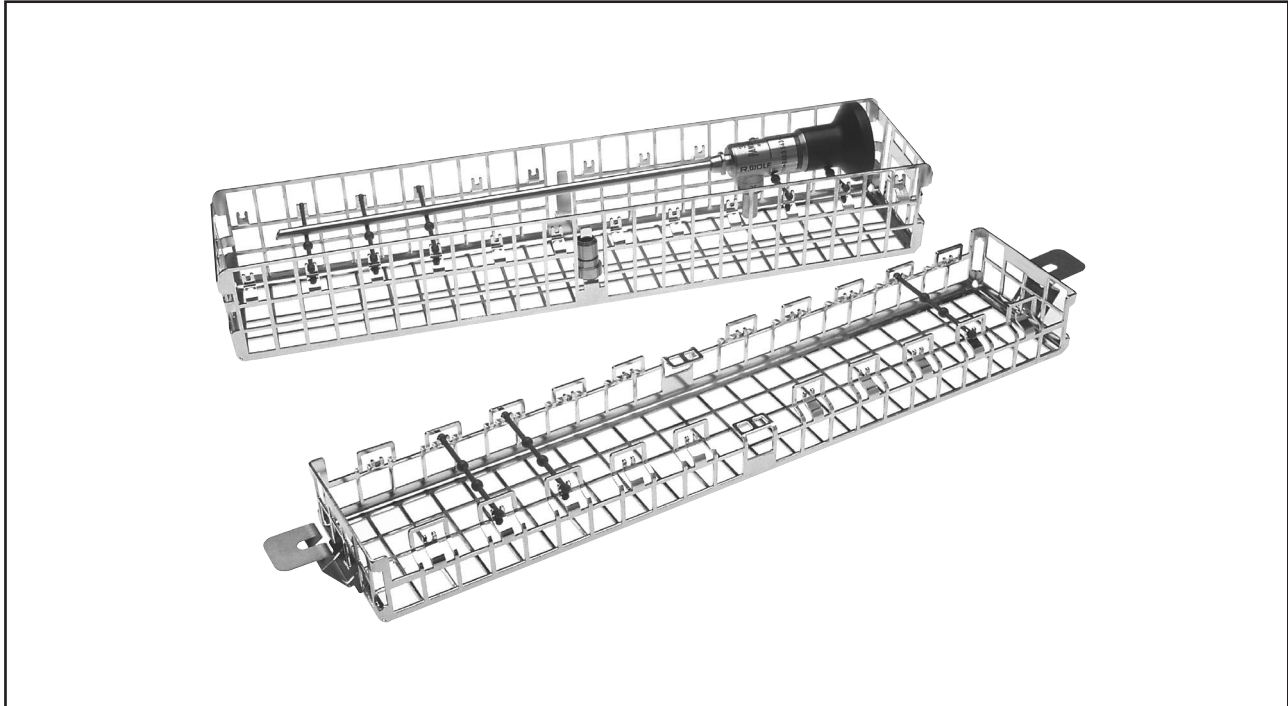

	Breite / Width mm	Länge / Length mm	Höhe / Height mm	Gewicht / Weight g	Type / Type
Aufbereitungskörbe für alle endoskopischen Optiken Aufnahmekapazität: 1 Endoskop Reprocessing baskets for all endoscopic telescopes Capacity: 1 endoscope	59	287	54	255	38020.111
		471		355	38021.111
		610		410	38022.111

also:
Ball fixers
 for reprocessing baskets,
 per 20 pieces38015.001

hierzu:
Kugelketten
 für Aufbereitungskörbe,
 VE = 20 Stck38015.001

*Reprocessing Baskets
for Standard Endoscopes*

*for machine reprocessing
and sterilization*

Aufbereitungskörbe
für Standard-Endoskope

für die maschinelle Aufbereitung
und Sterilisation

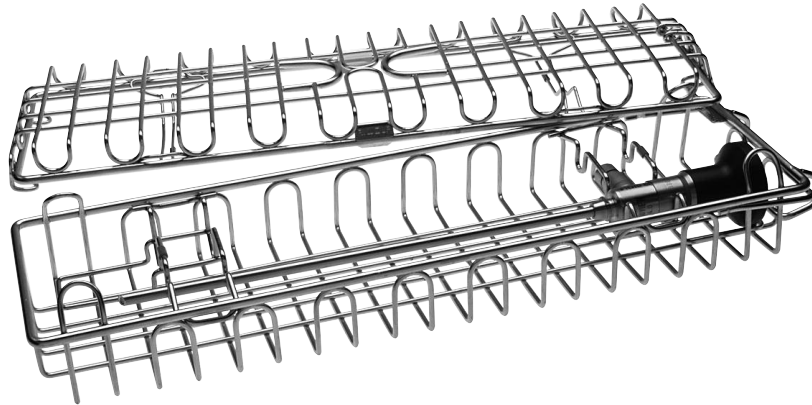

	für Optik-Ø / for telescope Ø mm	Breite / Width mm	Länge / Length mm	Gesamthöhe / Total height mm	Type / Type	
Aufbereitungskörbe für Standard-Endoskope Aufnahmekapazität: je 2 Endoskope Reprocessing baskets for standard endoscopes Capacity: 2 endoscopes per basket	0 - 4	80	290	46	38010.011	
	4 - 8				38010.021	
	8 - 12				38010.031	
	0 - 4		450		610	38011.011
	4 - 8					38011.021
	8 - 12					38011.031
	0 - 4				38012.011	
	4 - 8				38012.021	
	8 - 12				38012.031	

*Sterilization Basket
for instruments for
reconstructive shoulder arthroscopy
for machine reprocessing and sterilization*

Sterilisationskorb
für Instrumentarium zur
rekonstruktiven Schulter-Arthroskopie
für die maschinelle Aufbereitung und Sterilisation

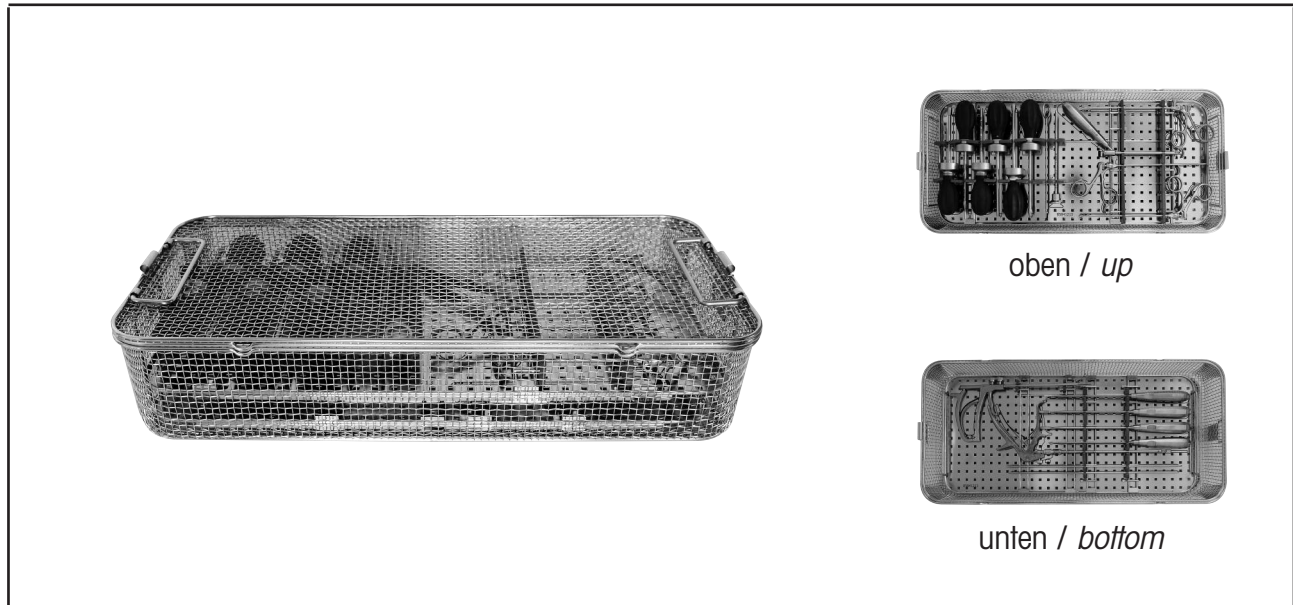

oben / up

unten / bottom

		Typen Types
<p>Sterilisationskorb für Instrumente zur rekonstruktiven Schulter-Arthroskopie</p> <p>Sterilization Basket for instruments for reconstructive shoulder arthroscopy</p>	<p>bestehend aus: 1x Siebkorbunterteil (8584.5202), 1x Siebkorbdeckel (8584.6201), 2x Verschluss kurz (8584.2002), 1x Instrumententräger, oben (74018097), 1x Aufnahmeeinheit (74018104), 1x Silikonaufnahme Set Schulter, oben (85849101) 1x Instrumententräger unten (74018098), 1x Aufnahmeeinheit (74018105), 1x Silikonaufnahme Set Schulter, unten (85849102)</p> <p>consisting of: 1x basket lower part (8584.5202), 1x basket lid (8584.6201), 2x spring lock short (8584.2002), 1x instrument rack, up (74018097), 1x support bar (74018104), 1x silicone holder set shoulder, up (85849101) 1x instrument rack, bottom (74018098), 1x support bar (74018105), 1x silicone holder set shoulder, bottom (85849102)</p>	<p>85841213</p>
<p>hierzu: / also:</p>		
<p>Silikonaufnahme-Set Schulter, oben</p> <p>Silicon holder set shoulder, up</p>	<p>bestehend aus: 1 x Silikonaufnahme 8 Öffnungen 1 x Silikonaufnahme 8 Öffnungen 2 x Silikonaufnahme 4 Öffnungen</p> <p>consisting of: 1 x silicon holder 8 vents 1 x silicon holder 8 vents 2 x silicon holder 4 vents</p>	<p>85849101</p>
<p>Silikonaufnahme-Set Schulter, unten</p> <p>Silicon holder set shoulder, bottom</p>	<p>bestehend aus: 2 x Silikonaufnahme 1 Öffnung 2 x Silikonaufnahme 6 Öffnungen</p> <p>consisting of: 2 x silicon holder 1 vent 2 x silicon holder 6 vents</p>	<p>85849102</p>

*Sterilization Basket
for instruments for
decompression of the Ulnar Nerve
for machine reprocessing and sterilization*

Sterilisationskorb
für Instrumente zur
Dekompression des Nervus Ulnaris
für die maschinelle Aufbereitung und Sterilisation

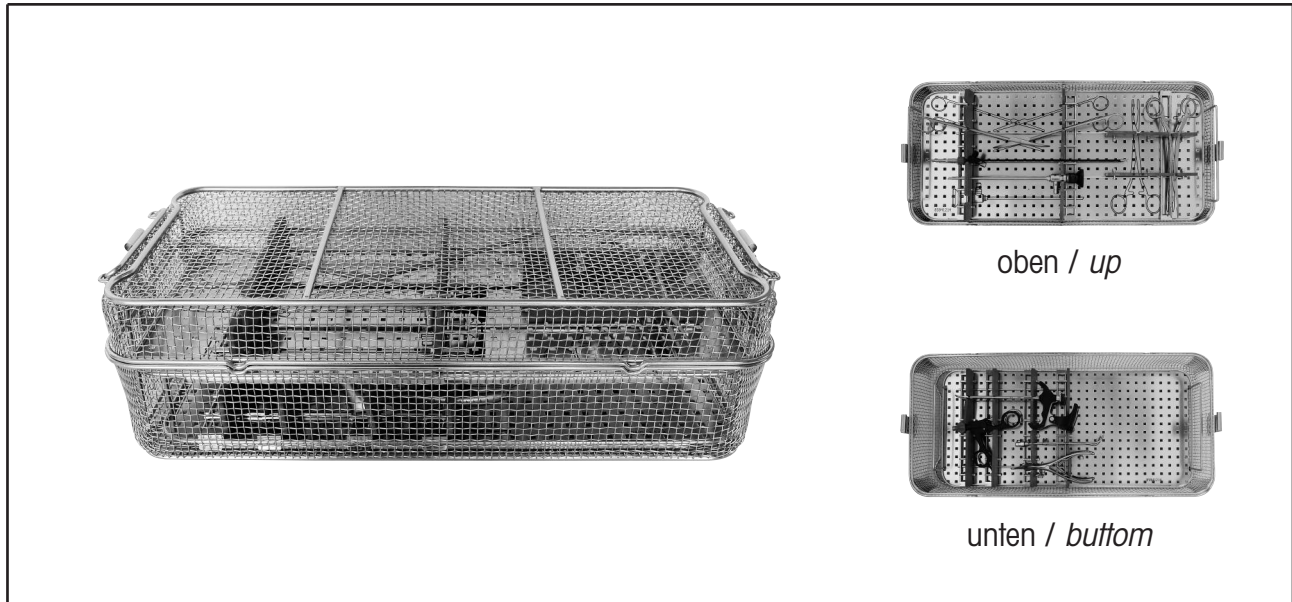

1

		Typen Types
<p>Sterilisationskorb für Instrumente zur Dekompression des Nervus Ulnaris</p> <p><i>Sterilization Basket for instruments for decompression of the Ulnar Nerve</i></p>	<p>bestehend aus: 1x Siebkorbunterteil (8584.5202), 1x Siebkorbdeckel (74018096), 2x Verschluss mittel (74015043), 1x Instrumententräger, oben (74018099), 1x Aufnahmeeinheit (74018106), 1x Silikonaufnahme Set Sul. Ulnaris, oben (85849103), 1x Instrumententräger, unten (74018100), 1x Aufnahmeeinheit (74018107), 1x Silikonaufnahme Set Sulcus Ulnaris, unten (85849104)</p> <p><i>consisting of: 1x basket lower part (8584.5202), 1x basket lid (74018096), 2x spring lock medium (74015043), 1x instrument rack, up (74018099), 1x support bar (74018106), 1x silicone holder set sul. ulnaris, up (85849103) 1x instrument rack, bottom (74018100), 1x support bar (74018107), 1x silicone holder set sulcus ulnaris, bottom (85849104)</i></p>	85841214
hierzu: / also:		
<p>Silikonaufnahme-Set Sulcus Ulnaris, oben</p> <p><i>Silicon holder set sulcus ulnaris, up</i></p>	<p>bestehend aus: 2x Silikonaufnahme 3 Öffnungen 2x Silikonaufnahme 5 Öffnungen</p> <p><i>consisting of: 2x silicon holder 3 vents 2x silicon holder 5 vents</i></p>	85849103
<p>Silikonaufnahme-Set Sulcus Ulnaris, unten</p> <p><i>Silicon holder set sulcus ulnaris, bottom</i></p>	<p>bestehend aus: 2x Silikonaufnahme 2 Öffnungen 2x Silikonaufnahme 4 Öffnungen</p> <p><i>consisting of: 2x silicon holder 2 vents 2x silicon holder 4 vents</i></p>	85849104

*Reprocessing Baskets
for Camera Heads*

*for machine reprocessing
and sterilization*

Aufbereitungskörbe
für Kameraköpfe

für die maschinelle Aufbereitung
und Sterilisation



1

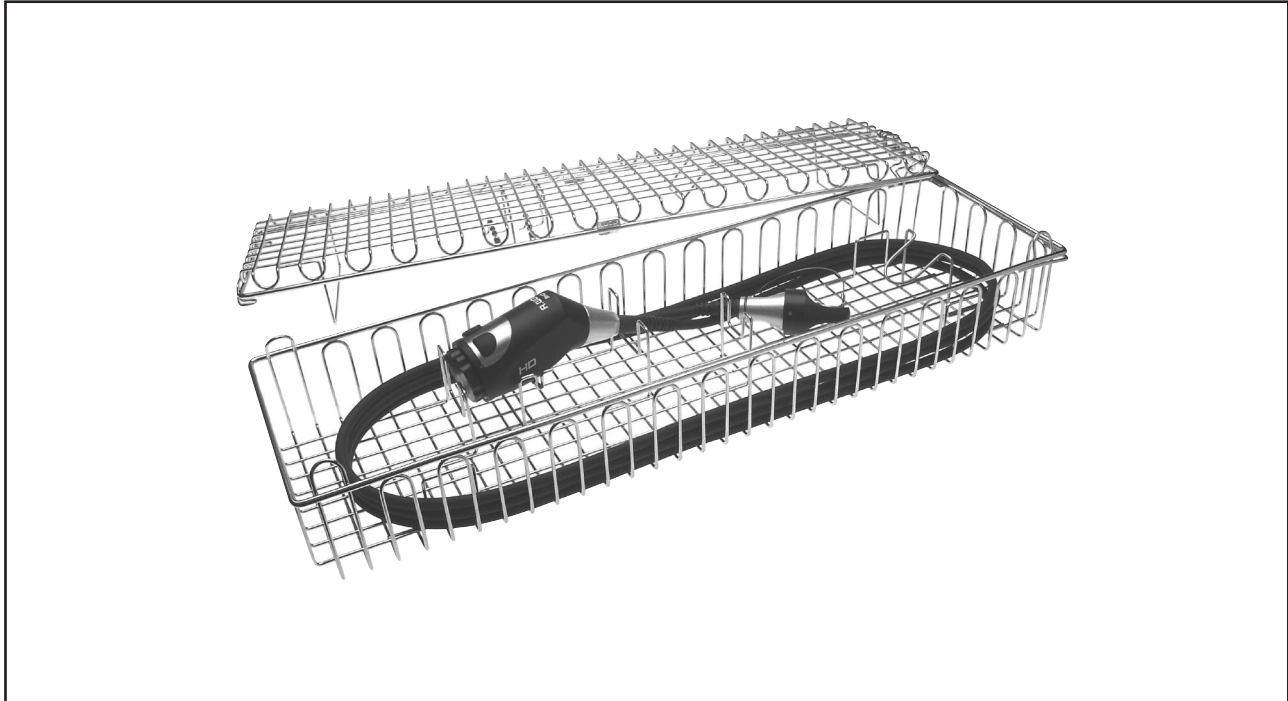

	passend für <i>suitable for</i>	Breite / <i>Width</i> mm	Länge / <i>Length</i> mm	Gesamthöhe / <i>Total height</i> mm	Type / <i>Type</i>
Aufbereitungskorb <i>Reprocessing basket</i>	Kameraköpfe: <i>Camera heads:</i> 5509912 5509972 85509902 85509962	132	472	74	38044.511

You will find further baskets in the catalogues of the specialist disciplines.

Weitere Körbe finden Sie in den jeweiligen Fachgebieten-Katalogen.

Reprocessing Baskets
for **eyeMAX**® CCD Endoscopes
for machine reprocessing
and sterilization

Aufbereitungskörbe
für **eyeMAX**® CCD-Endoskope
für die maschinelle Aufbereitung
und Sterilisation

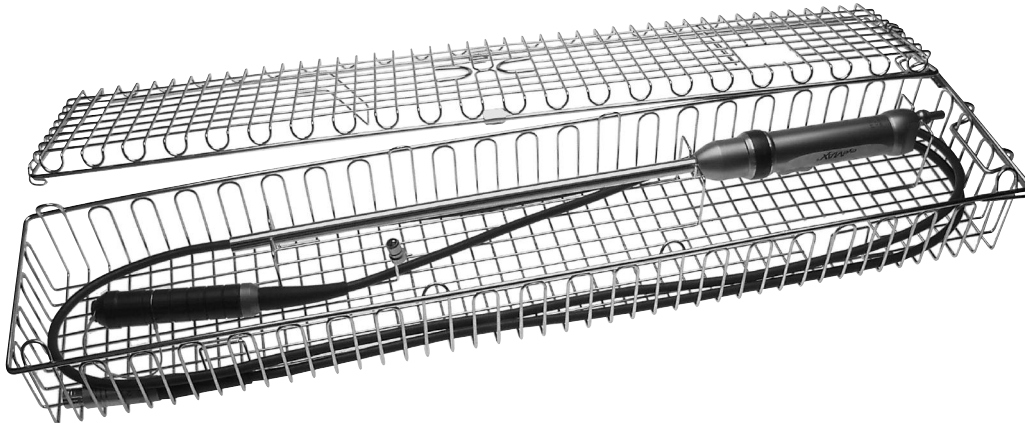

	passend für <i>suitable for</i>	Breite / <i>Width</i> mm	Länge / <i>Length</i> mm	Gesamthöhe / <i>Total height</i> mm	Type / <i>Type</i>
Aufbereitungskorb für eyeMAX® CCD-Endoskope Aufnahmekapazität: 1 CCD Endoskop und 1 Kamerakabel Reprocessing basket for eyeMAX® CCD endoscopes Capacity: 1 CCD endoscope and 1 camera cable	eyeMAX® Endoskope: eyeMAX® endoscopes: 8934.xxx	132	584	74	38045.211

You will find further baskets in the catalogues of the specialist disciplines.

Weitere Körbe finden Sie in den jeweiligen Fachgebieten-Katalogen.

*Reprocessing Baskets
for URS, Miniature Nephroscope and
US Transducer
for machine reprocessing and sterilization*

Aufbereitungskörbe
für URS, Mini-Nephroskop und
US-Transducer
für die maschinelle Aufbereitung und Sterilisation

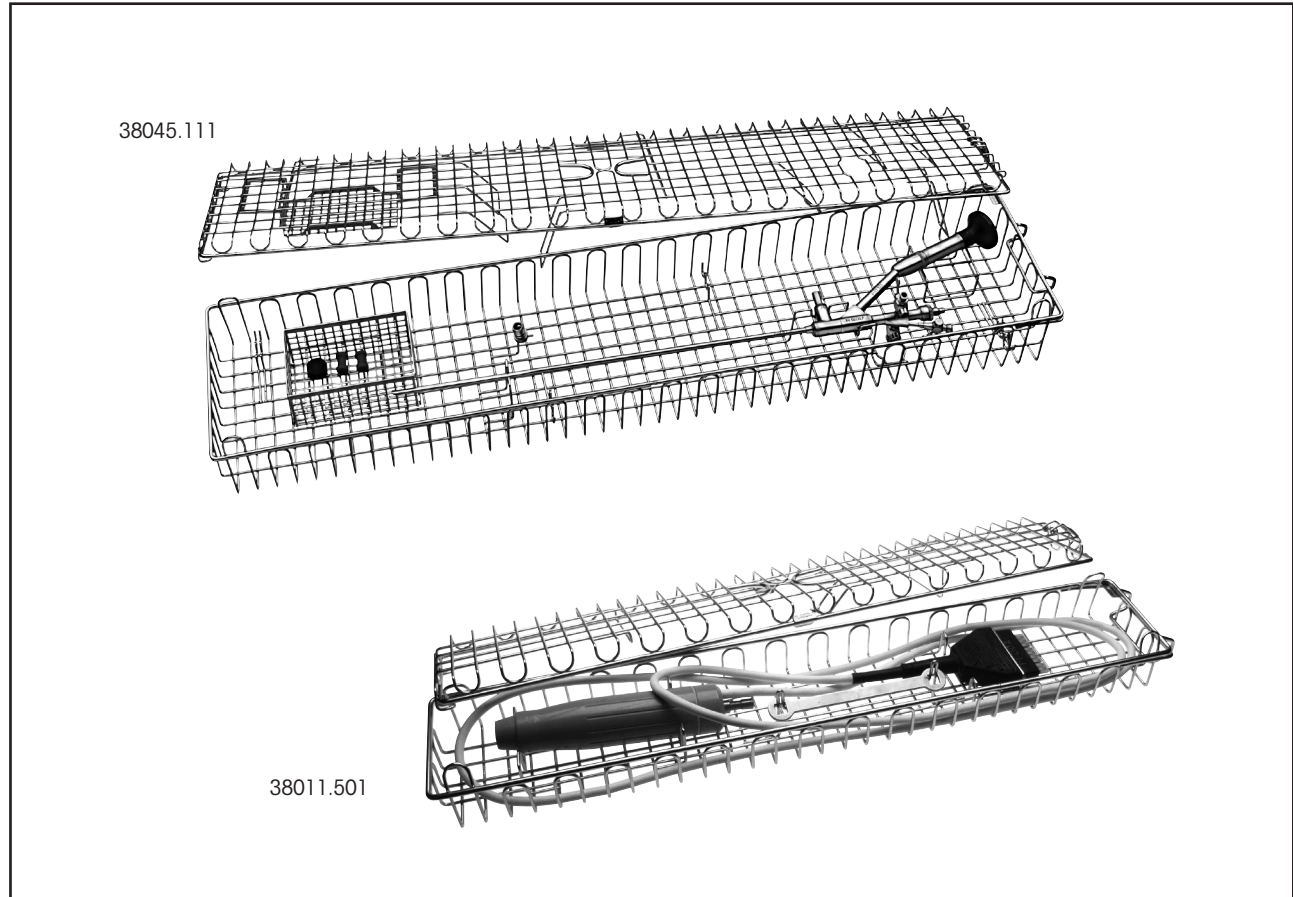

	passend für <i>suitable for</i>	Breite / <i>Width</i> mm	Länge / <i>Length</i> mm	Gesamthöhe / <i>Total height</i> mm	Type / <i>Type</i>
Aufbereitungskorb mit zusätzlichen Halterungen für Sonotroden Reprocessing basket <i>with additional mountings for sonotrodes</i>	URS / <i>URS</i> : 8701.xxx 8702.xxx 8703.xxx 8704.xxx 8708.xxx Mini-Nephroskop: <i>Miniature nephroscope</i> : 8968.421	132	640	74	38045.111
Aufbereitungskorb für US-Transducer (2271.501) inkl. Ringschlüssel (64262.012) Reprocessing basket <i>for US transducer (2271.501) incl. ring key (64262.012)</i>	US-Transducer: <i>US transducer</i> : 2271.501	80	450	46	38011.501

You will find further baskets in the catalogues of the specialist disciplines.

Weitere Körbe finden Sie in den jeweiligen Fachgebieten-Katalogen.

*Reprocessing Baskets
for Cysto-Urethroscope, Operating
Telescopes, Mini-Operating Telescope
for machine reprocessing and sterilization*

Aufbereitungskörbe
für Cysto-Urethroskop, Operati-
ons-Optiken, Mini-OP-Endoskop
für die maschinelle Aufbereitung und Sterilisation

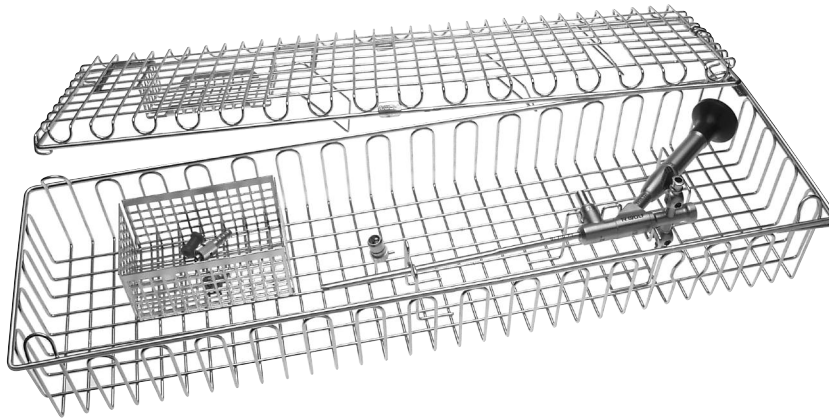

	passend für <i>suitable for</i>	Breite / <i>Width</i> mm	Länge / <i>Length</i> mm	Gesamthöhe / <i>Total height</i> mm	Type / <i>Type</i>
Aufbereitungskorb Reprocessing basket	Operations-Cysto- Urethroskop: <i>Operating</i> <i>cysto-urethroscope:</i> 8626.531 PANOVIEW PLUS- Operations-Optiken: <i>PANOVIEW PLUS-</i> <i>operating telescopes:</i> 8632.411 8643.401 Mini-OP-Endoskop: <i>Mini-operating</i> <i>telescope:</i> 8746.401	132	472	74	38044.611

You will find further baskets in the catalogues of the specialist disciplines.

Weitere Körbe finden Sie in den jeweiligen Fachgebieten-Katalogen.

*Reprocessing Baskets
for Nephroscopes*

*for machine reprocessing
and sterilization*

Aufbereitungskörbe
für Nephroskope

für die maschinelle Aufbereitung
und Sterilisation



1

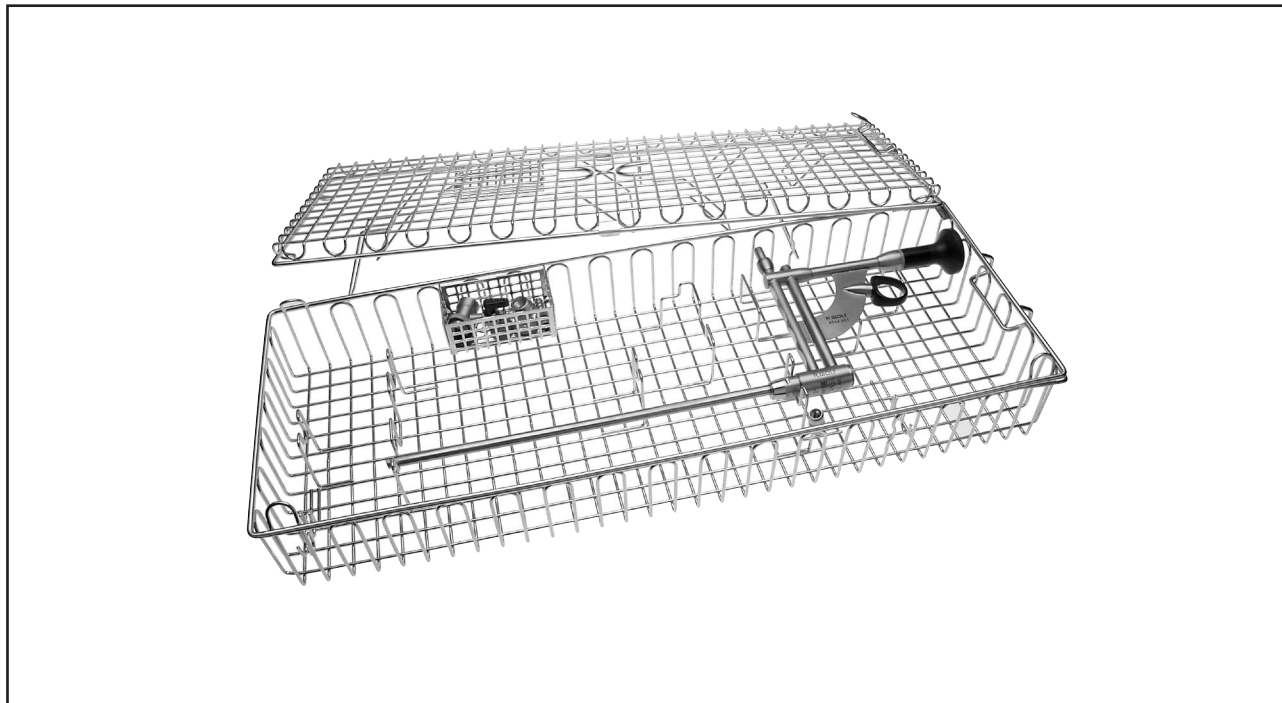

	passend für <i>suitable for</i>	Breite / <i>Width</i> mm	Länge / <i>Length</i> mm	Gesamthöhe / <i>Total height</i> mm	Type / <i>Type</i>
Aufbereitungskorb <i>Reprocessing basket</i>	Nephroskope: <i>Nephroscopes:</i> 8964.401 8965.401 8965.411 8966.401	172	458	73	38042.311

You will find further baskets in the catalogues of the specialist disciplines.

Weitere Körbe finden Sie in den jeweiligen Fachgebieten-Katalogen.

*Reprocessing Basket
for Exchangeable Sheath Hysteroscope
for machine reprocessing
and sterilization*

Aufbereitungskorb
für Wechselschaft-Hysteroskop
für die maschinelle Aufbereitung
und Sterilisation

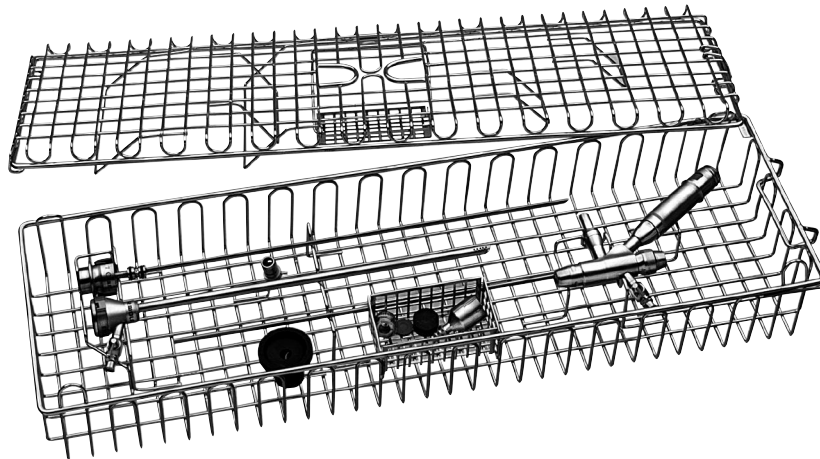

	passend für <i>suitable for</i>	Breite / <i>Width</i> mm	Länge / <i>Length</i> mm	Gesamthöhe / <i>Total height</i> mm	Type / <i>Type</i>
Aufbereitungskorb für Wechselschaft-Hysteroskop mit Aufnahme für Wechselschäfte Reprocessing basket for exchangeable sheath hysteroscope with mounting for exchangeable sheaths	Wechselschaft- Hysteroskop: <i>Exchangeable sheath hystero- scope:</i> 8753.411	132	472	74	38044.311

You will find further baskets in the catalogues of the specialist disciplines.

Weitere Körbe finden Sie in den jeweiligen Fachgebieten-Katalogen.

*Reprocessing Basket
for Hysteroscopes, Discoscopes
and MR Endoscope
for machine reprocessing and sterilization*

Aufbereitungskorb
für Hysteroskope, Diskoskope
und MR-Endoskop
für die maschinelle Aufbereitung und Sterilisation



1

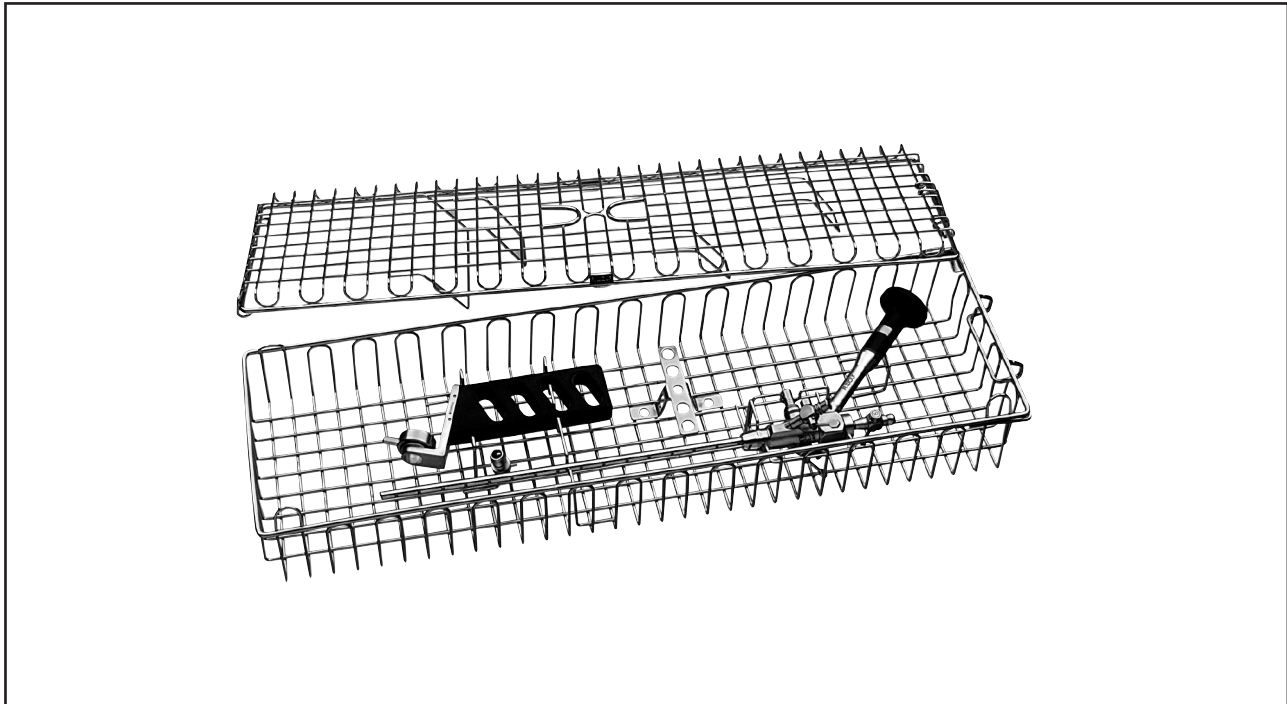

	passend für <i>suitable for</i>	Breite / <i>Width</i> mm	Länge / <i>Length</i> mm	Gesamthöhe / <i>Total height</i> mm	Type / <i>Type</i>
Aufbereitungskorb <i>Reprocessing basket</i>	Hysteroskop nach Grochmal: <i>Hysteroscope by Grochmal :</i> 8986.401 Mini-Kompakt-Dauerspül- Operations-Hysteroskop: <i>Mini compact continuous-flow operating hysteroscope:</i> 8977.411 Diskoskope: <i>Discoscopes:</i> 8793.401 8792.401 8792.411 Magnet-Resonanz-Endoskop nach Tronnier: <i>Magnetic resonance endoscope by Tronnier:</i> 8767.412	132	472	89	38044.111

You will find further baskets in the catalogues of the specialist disciplines.

Weitere Körbe finden Sie in den jeweiligen Fachgebieten-Katalogen.

*Reprocessing Basket
for Discoscopes*

*for machine reprocessing
and sterilization*

Aufbereitungskorb
für Diskoskope

für die maschinelle Aufbereitung
und Sterilisation

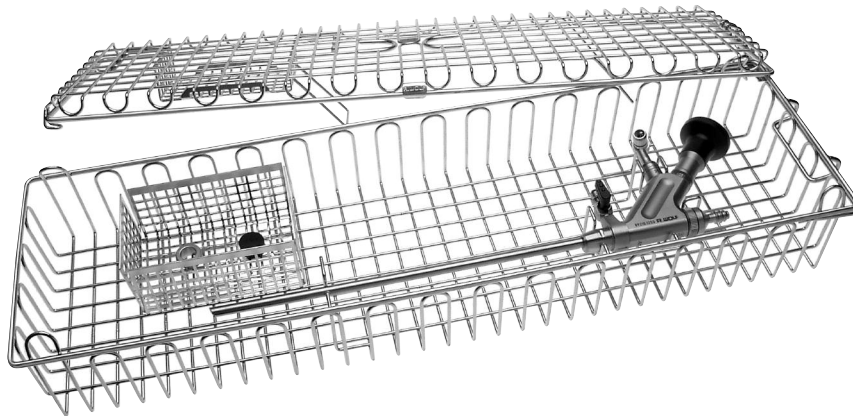

	passend für <i>suitable for</i>	Breite / <i>Width</i> mm	Länge / <i>Length</i> mm	Gesamthöhe / <i>Total height</i> mm	Type / <i>Type</i>
Aufbereitungskorb Reprocessing basket	Diskoskope: <i>Discoscopes:</i> 89210.1253 89210.1254 89210.3253 89210.3254	132	472	74	38044.411

You will find further baskets in the catalogues of the specialist disciplines.

Weitere Körbe finden Sie in den jeweiligen Fachgebiets-Katalogen.

*Reprocessing Basket
for Mini-Laparoscope*

*for machine reprocessing
and sterilization*

Aufbereitungskorb
für Mini-Laparoskop

für die maschinelle Aufbereitung
und Sterilisation



1

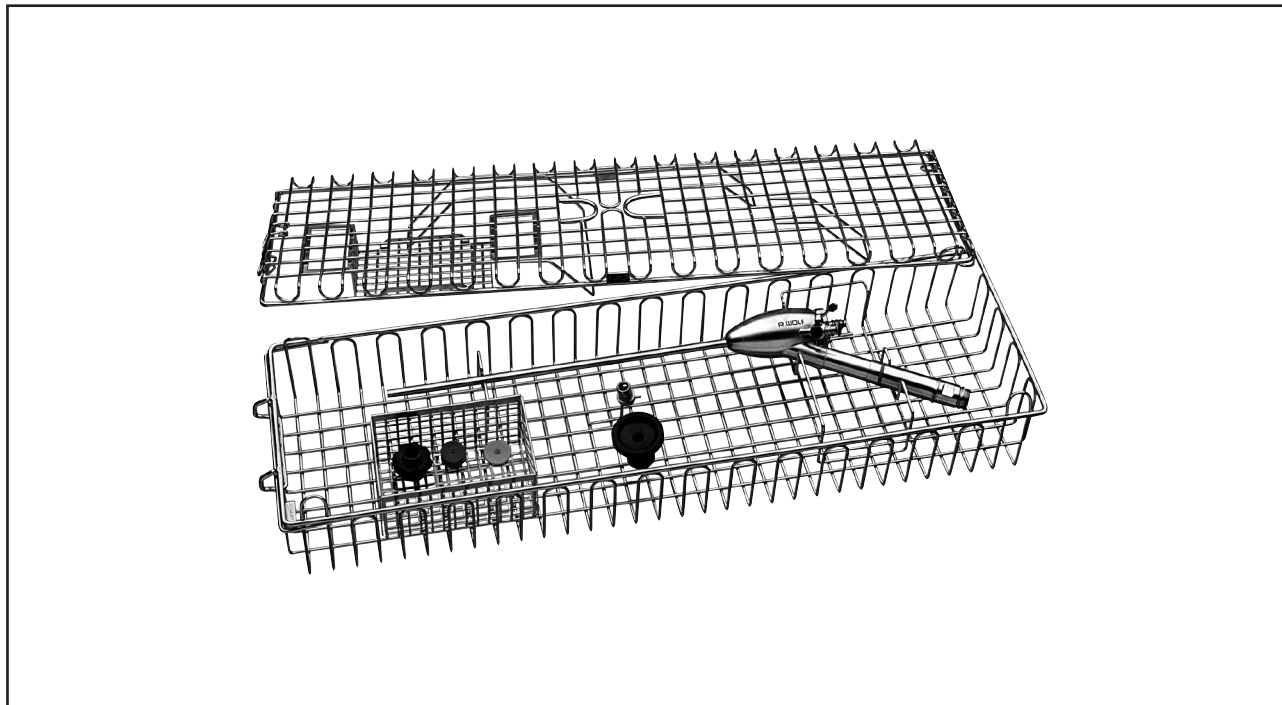

	passend für <i>suitable for</i>	Breite / <i>Width</i> mm	Länge / <i>Length</i> mm	Gesamthöhe / <i>Total height</i> mm	Type / <i>Type</i>
Aufbereitungskorb <i>Reprocessing basket</i>	Mini-Laparoskop: <i>Mini-laparoscope:</i> 8920.4011	132	472	74	38044.211

You will find further baskets in the catalogues of the specialist disciplines.

Weitere Körbe finden Sie in den jeweiligen Fachgebieten-Katalogen.

*Reprocessing Baskets
for RectoLution-Scope, Intramedullary Bone
Endoscopy Set and Operating Telescopes
for machine reprocessing and sterilization*

Aufbereitungskörbe
für RectoLution-Scope, Markraum-
Endoskopie-Set, Operations-Optiken
für die maschinelle Aufbereitung und Sterilisation

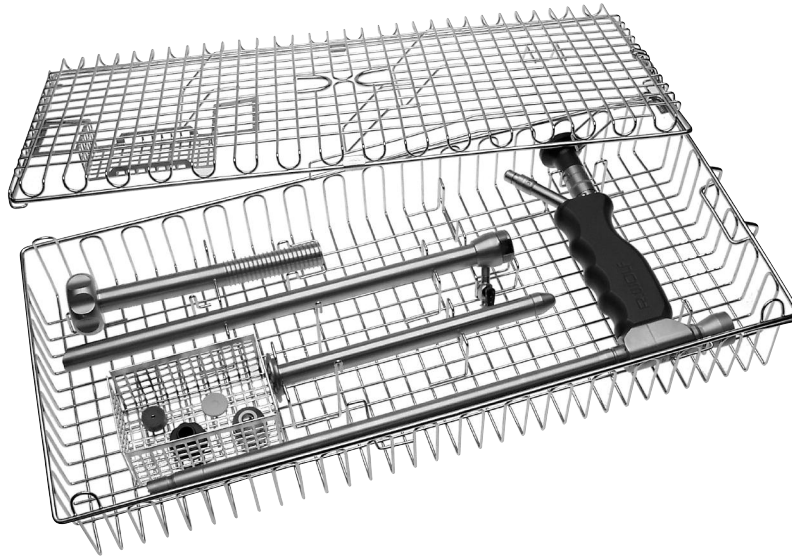

	passend für <i>suitable for</i>	Breite / <i>Width</i> mm	Länge / <i>Length</i> mm	Gesamthöhe / <i>Total height</i> mm	Type / <i>Type</i>
Aufbereitungskorb Reprocessing basket	RectoLution-Scope: <i>RectoLution-Scope:</i> 8830.401 Markraum-Endo- skopie-Set: <i>intramedullary bone</i> <i>endoscopy :</i> 89300.0001 Operations-Optiken: <i>Operating telescopes:</i> 8781.4031 8781.423	204	472	74	38046.111

You will find further baskets in the catalogues of the specialist disciplines.

Weitere Körbe finden Sie in den jeweiligen Fachgebieten-Katalogen.

Sterilization Basket System

Sterilisations-Siebkorbsystem

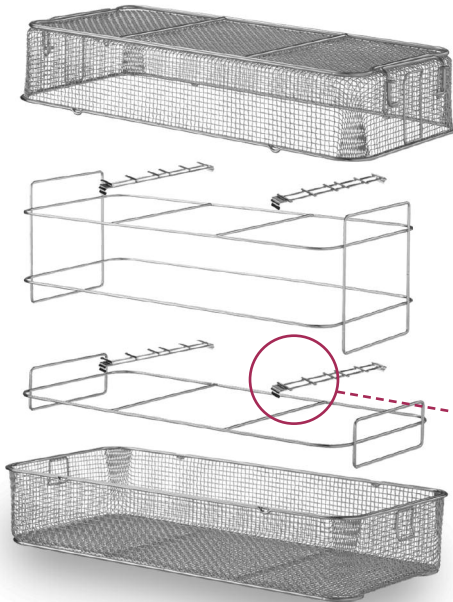

Das RICHARD WOLF Siebkorbssystem, universell verwendbar, dient der sicheren und schonenden Aufnahme des wertvollen Instrumentariums während

- der Sterilisation
- des Transportes
- der Lagerung.

Durch das universelle Siebkonzept lässt sich fast jede Siebkonfiguration zusammenstellen.

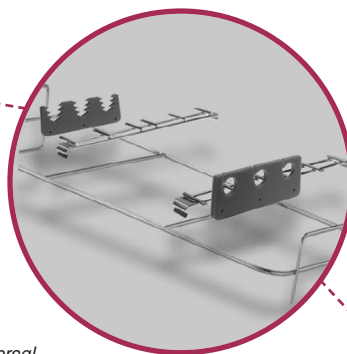

RICHARD WOLF's open mesh basket system, which has universal application, holds even the most expensive instruments safely and carefully during

- sterilization
- transport
- storage.

The universal basket concept allows almost any basket configuration to be set up.

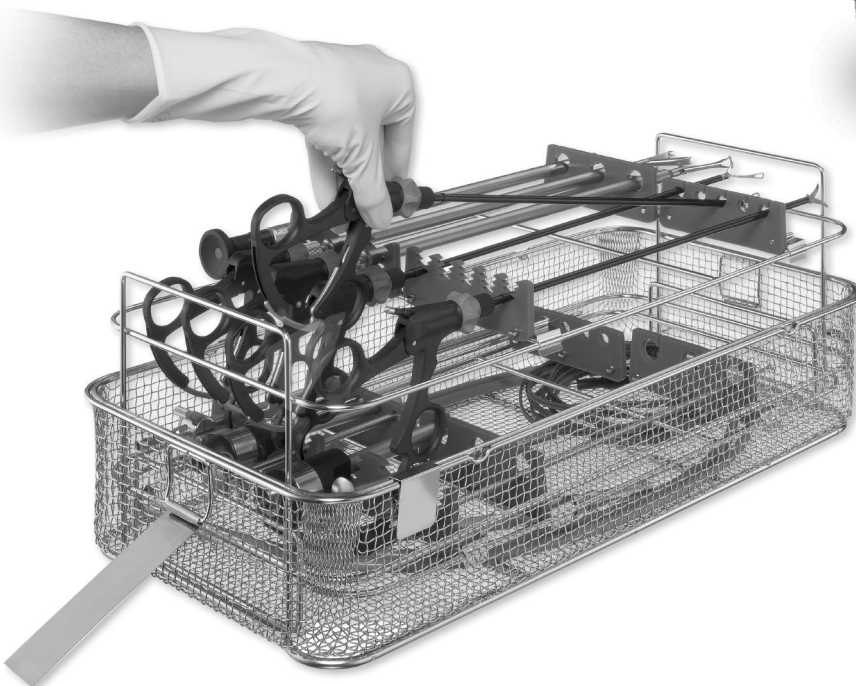
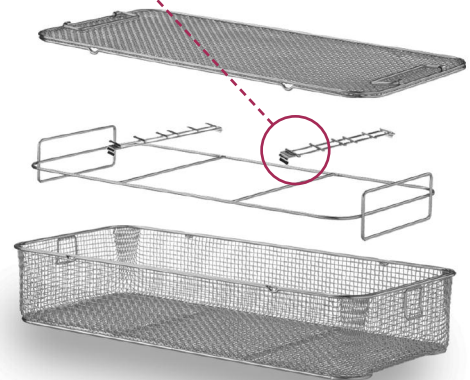

Sterilization Basket System

Sterilisations-Siebkorbsystem

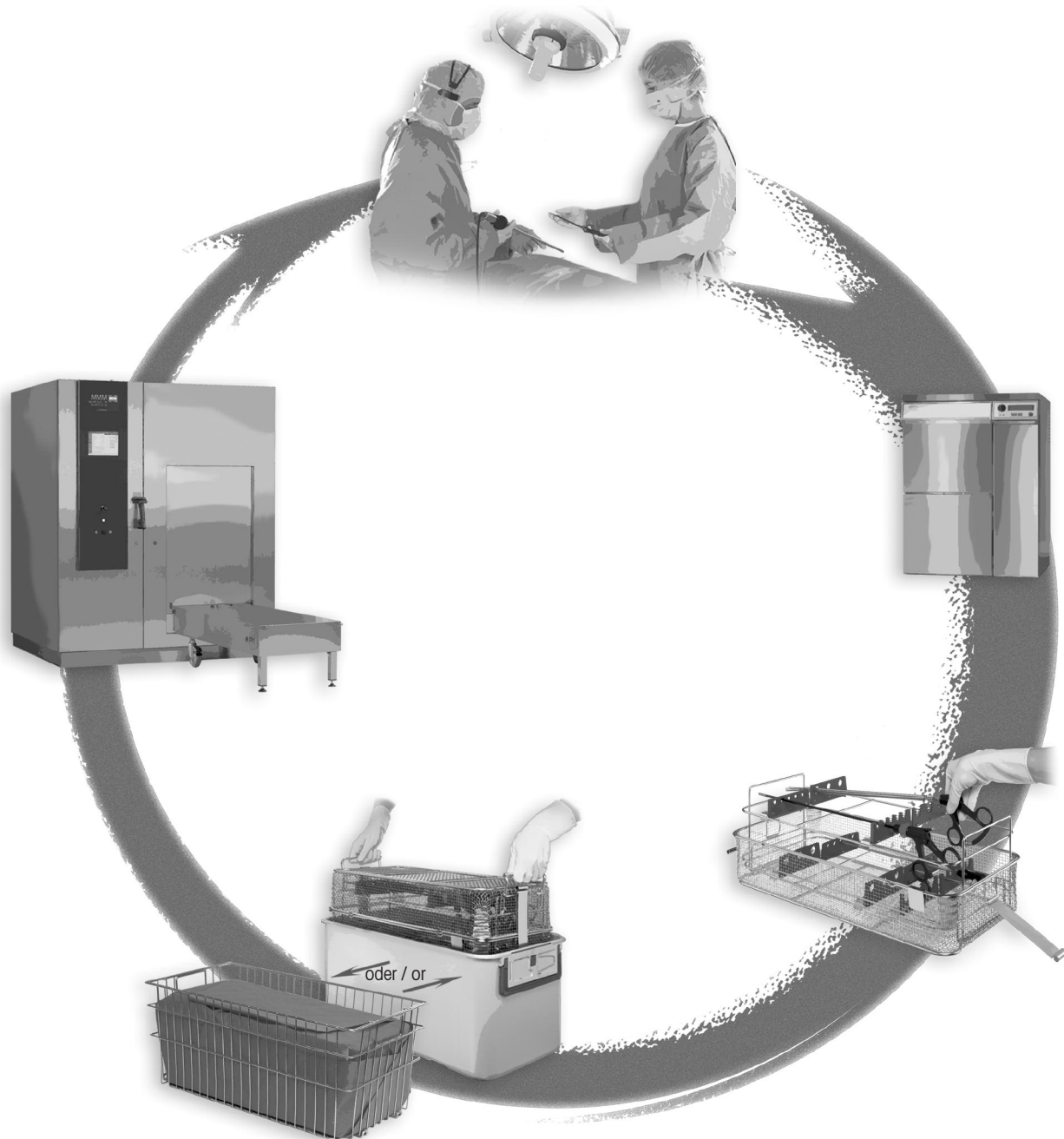

Sterilization Basket System
for sterilization, transport and storage

Sterilisation-Siebkorbsystem
für Sterilisation, Transport und Lagerung



1

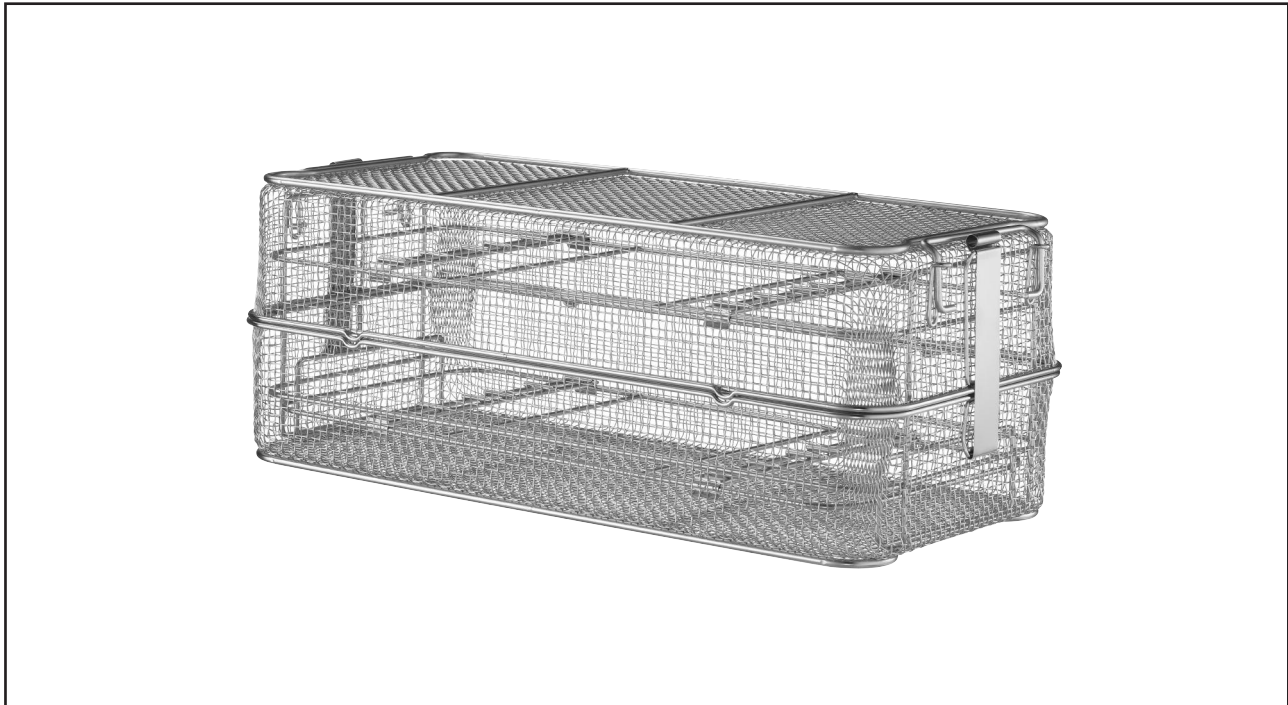

	Breite / Width mm	Länge / Length mm	Gesamthöhe / Total height mm	Gewicht / Weight kg	Type / Type
<p>Instrumentensieb, hoch - Standard bestehend aus: Siebkorbunterteil (8584.5202), Siebkorbdeckel hoch(8584.6202), Verschluss 2 x, Instrumententräger hoch (8584.7203), Instrumententräger niedrig (8584.7204), Aufnahmesteg 4 x (8584.8203)</p> <p>Instrument basket, high - standard contains: basket lower part (8584.5202), lid high (8584.6202), spring lock 2 x, instrument rack deep (8584.7203), instrument rack flat (8584.7204), support bar 4 x (8584.8203)</p>	250	530	200	3.5	8584.1202

suitable for standard container

passend für Standard Container (1 STE = 1 Sterilguteinheit)

You will find further baskets in the catalogues of the specialist disciplines.
Accessories see page J 23 - J 24.

Weitere Körbe finden Sie in den jeweiligen Fachgebiets-Katalogen
Zubehör siehe Seite J 23 - J 24.

Sterilization Basket System
for sterilization, transport and storage

Sterilisation-Siebkorbsystem
für Sterilisation, Transport und Lagerung

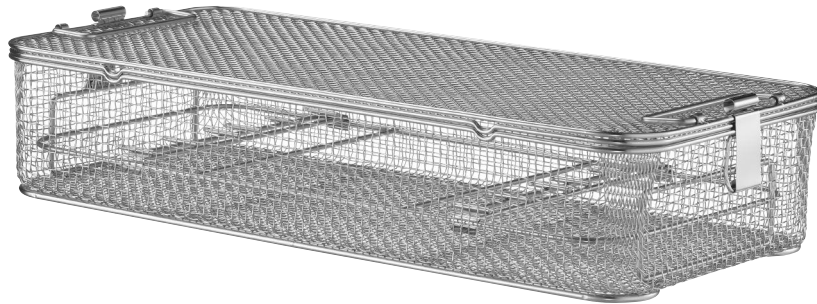

1

	Breite / Width mm	Länge / Length mm	Gesamthöhe / Total height mm	Gewicht / Weight kg	Type / Type
<p>Instrumentensieb, niedrig - Standard bestehend aus: Siebkorbunterteil (8584.5202), Siebkorbdeckel flach (8584.6201), Verschluss 2 x, Instrumententräger niedrig (8584.7204), Aufnahmesteg 2 x (8584.8203)</p> <p>Instrument basket, flat - standard contains: basket lower part (8584.5202), lid flat (8584.6201), spring lock 2 x, instrument rack flat (8584.7204), support bar 2 x (8584.8203)</p>	250	530	108	2.2	8584.1212

suitable for standard container

passend für Standard Container (1 STE = 1 Sterilguteinheit)

You will find further baskets in the catalogues of the specialist disciplines.
Accessories see page J 23 - J 24.

Weitere Körbe finden Sie in den jeweiligen Fachgebiets-Katalogen
Zubehör siehe Seite J 23 - J 24.

Sterilization Basket System
for sterilization, transport and storage

Sterilisation-Siebkorbsystem
für Sterilisation, Transport und Lagerung



1

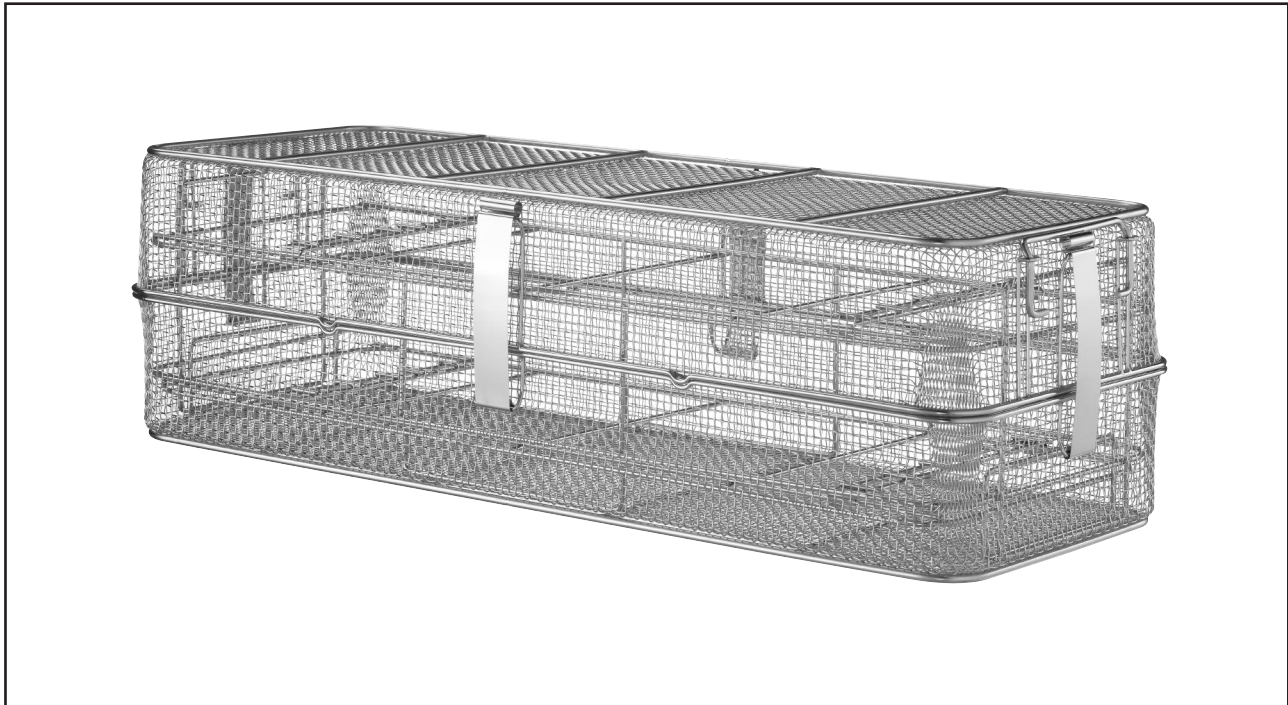

	Breite / Width mm	Länge / Length mm	Gesamthöhe / Total height mm	Gewicht / Weight kg	Type / Type
<p>Instrumentensieb, hoch - lang bestehend aus: Siebkorbunterteil (8584.5302), Siebkorbdeckel hoch (8584.6302), Verschluss 4 x, Instrumententräger hoch (8584.7205), Instrumententräger niedrig (8584.7206), Aufnahmesteg 4 x (8584.8203)</p> <p>Instrument basket, high - long contains: basket lower part (8584.5302), lid high (8584.6302), spring lock 4 x, instrument rack high (8584.7205), instrument rack flat (8584.7206), support bar 4 x (8584.8203)</p>	275	725	200	5.0	8584.1302

Extra-long e.g. for bronchoscopy, urology (upper urinary tract)

Überlänge z.B. für Bronchoskopie, Urologie (oberer Harntrakt)

You will find further baskets in the catalogues of the specialist disciplines.
Accessories see page J 23 - J 24.

Weitere Körbe finden Sie in den jeweiligen Fachgebiets-Katalogen
Zubehör siehe Seite J 23 - J 24.

Sterilization Basket System
for sterilization, transport and storage

Sterilisation-Siebkorbsystem
für Sterilisation, Transport und Lagerung

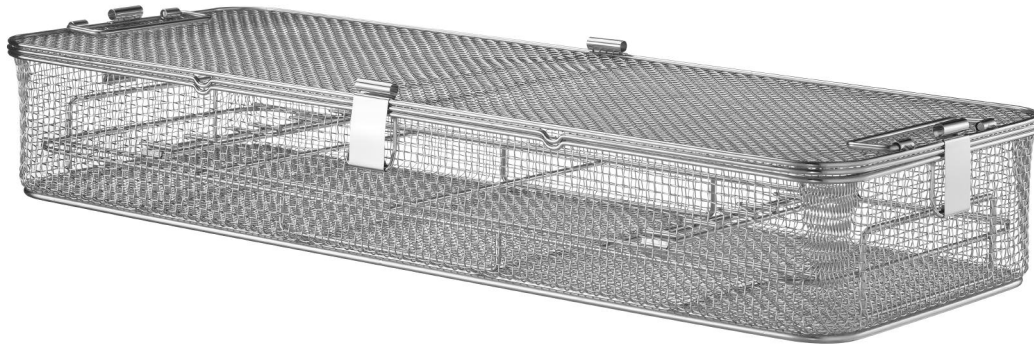

	Breite / Width mm	Länge / Length mm	Gesamthöhe / Total height mm	Gewicht / Weight kg	Type / Type
<p>Instrumentensieb, niedrig - lang bestehend aus: Siebkorbunterteil (8584.5302), Siebkorbdeckel flach (8584.6301), Verschluss 4 x, Instrumententräger niedrig (8584.7206), Aufnahmesteg 2 x (8584.8203)</p> <p>Instrument basket, flat - long contains: basket lower part (8584.5302), lid flat (8584.6301), spring lock 4 x, instrument rack flat (8584.7206), support bar 2 x (8584.8203)</p>	275	725	108	3.1	8584.1312

Extra-long e.g. for bronchoscopy, urology (upper urinary tract)

Überlänge z.B. für Bronchoskopie, Urologie (oberer Harntrakt)

You will find further baskets in the catalogues of the specialist disciplines.
Accessories see page J 23 - J 24.















Weitere Körbe finden Sie in den jeweiligen Fachgebiets-Katalogen
Zubehör siehe Seite J 23 - J 24.

Accessories

for sterilization basket system

Zubehör

zum Sterilisation-Siebkorbsystem













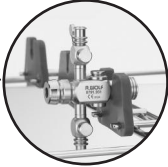

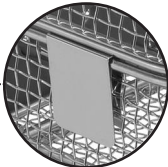

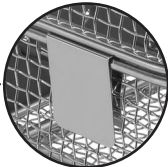

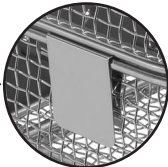
	Bezeichnung / Article description	Type / Type
	Aufnahmesteg für Silikonaufnahmen, 2-fach <i>Support bar for silicone holder, double</i>	8584.8203
	Silikonaufnahmen, geschlossen, 3-fach, für Instrumente von Ø 8 - 14,5 mm <i>Silicone holder, closed, triple,</i> <i>for instruments with diam. 8 to 14.5 mm</i>	8584.9201
	Silikonaufnahmen, offen, 3-fach, für Instrumente von Ø 8 - 14,5 mm <i>Silicone holder, open, triple,</i> <i>for instruments with diam. 8 to 14.5 mm</i>	8584.9211
	Silikonaufnahmen, geschlossen, 5-fach, für Instrumente von Ø 1 - 7,5 mm <i>Silicone holder, closed, for up to 5 items,</i> <i>for instruments with diam. 1 to 7.5 mm</i>	8584.9501
	Silikonaufnahmen, offen, 5-fach, für Instrumente von Ø 1 - 7,5 mm <i>Silicone holder, open, for up to 5 items,</i> <i>for instruments with diam. 1 to 7.5 mm</i>	8584.9511
	Silikonaufnahmen, geschlossen, 7-fach, für Instrumente von Ø 1 - 7,5 mm <i>Silicone holder, closed, for up to seven items,</i> <i>for instruments with diam. 1 to 7.5 mm</i>	8584.9701
	Silikonaufnahmen, offen, 7-fach für Instrumente von Ø 1 - 7,5 mm <i>Silicone holder, open, for up to seven items,</i> <i>for instruments with diam. 1 to 7.5 mm</i>	8584.9711
für Urologie / Arthroskopie <i>for Urology / Arthroscopy</i>  3x 8584.9501  1x 8584.9701  3x 8584.9511  1x 8584.9711	Starter Set Silikonaufnahmen bestehend aus: 3x 8584.9501, 3x 8584.9511, 1x 8584.9701, 1x 8584.9711 Starting Set Silicone Holder <i>consisting of: 3x 8584.9501, 3x 8584.9511,</i> <i>1x 8584.9701, 1x 8584.9711</i>	8584.9001
für Laparoskopie / Chirurgie / Gynäkologie <i>for Laparoscopy / Surgery / Gynaecology</i>  3x 8584.9501  1x 8584.9201  3x 8584.9511  1x 8584.9211	Starter Set Silikonaufnahmen bestehend aus: 3x 8584.9501, 3x 8584.9511, 1x 8584.9201, 1x 8584.9211 Starting Set Silicone Holder <i>consisting of: 3x 8584.9501, 3x 8584.9511,</i> <i>1x 8584.9201, 1x 8584.9211</i>	8584.9002

Accessories

for sterilization basket system

Zubehör

zum Sterilisation-Siebkorbsystem

	Bezeichnung / Article description	Type / Type
	Aufnahmesteg für Silikonaufnahmen, 3-fach, zur Aufnahme der Silikonaufnahmen Support bar for silicone holder, triple, to hold the silicone holders	8584.8201
  	Silikonaufnahmen, offen, Ø 9 mm, z.B. für einzelne Hähne Silicone holder, open, Ø 9 mm, e.g. for individual taps	8584.9111
 	Silikonaufnahmen, offen, Ø 4,5 mm, z.B. für einzelne Hähne Silicone holder, open, Ø 4.5 mm, e.g. for individual taps	8584.9112
  	Kennzeichnung breit, mit Federwirkung, (L x B x H) 60 x 35 x 9 mm Indicator holder, wide, with spring clip, (l x w x h) 60 x 35 x 9 mm	8584.2003
 	Kennzeichnung schmal, mit Federwirkung, (L x B x H) 30 x 35 x 9 mm Indicator holder, narrow, with spring clip, (l x w x h) 30 x 35 x 9 mm	8584.2004
 	Pendelsteckschild für Sterilindikatoren, (L x B x H) 41 x 14 x 57 mm Swinging plate for indicator labels, (l x w x h) 41 x 14 x 57 mm	8584.2006
 	Pendelsteckschild für Etikettenschilder, (L x B x H) 88 x 17 x 57 mm Swinging plate for indicator labels, (l x w x h) 88 x 17 x 57 mm	8584.2005
 	Systemkorb 1/1, (L x B x H) 295 x 580 x 250 mm, z.B. für den Transport von verpackten Siebkörben System basket 1/1, (l x w x h) 295 x 580 x 250 mm, e.g. for the transport of wrapped baskets	8584.3001
	System Kleinteilesieb 1/8, (L x B x H) 121 x 121 x 35 mm System basket, small, 1/8, (l x w x h) 121 x 121 x 35 mm	8584.3003
 	Arretierstift, z.B. für Handgriffe, VE = 2 Stück Locking bolt, e.g. for handle, package unit = 2 pcs.	8584.8205

RIWO-SYSTEM-TRAY
for sterilization

RIWO-SYSTEM-TRAY
für die Sterilisation



1

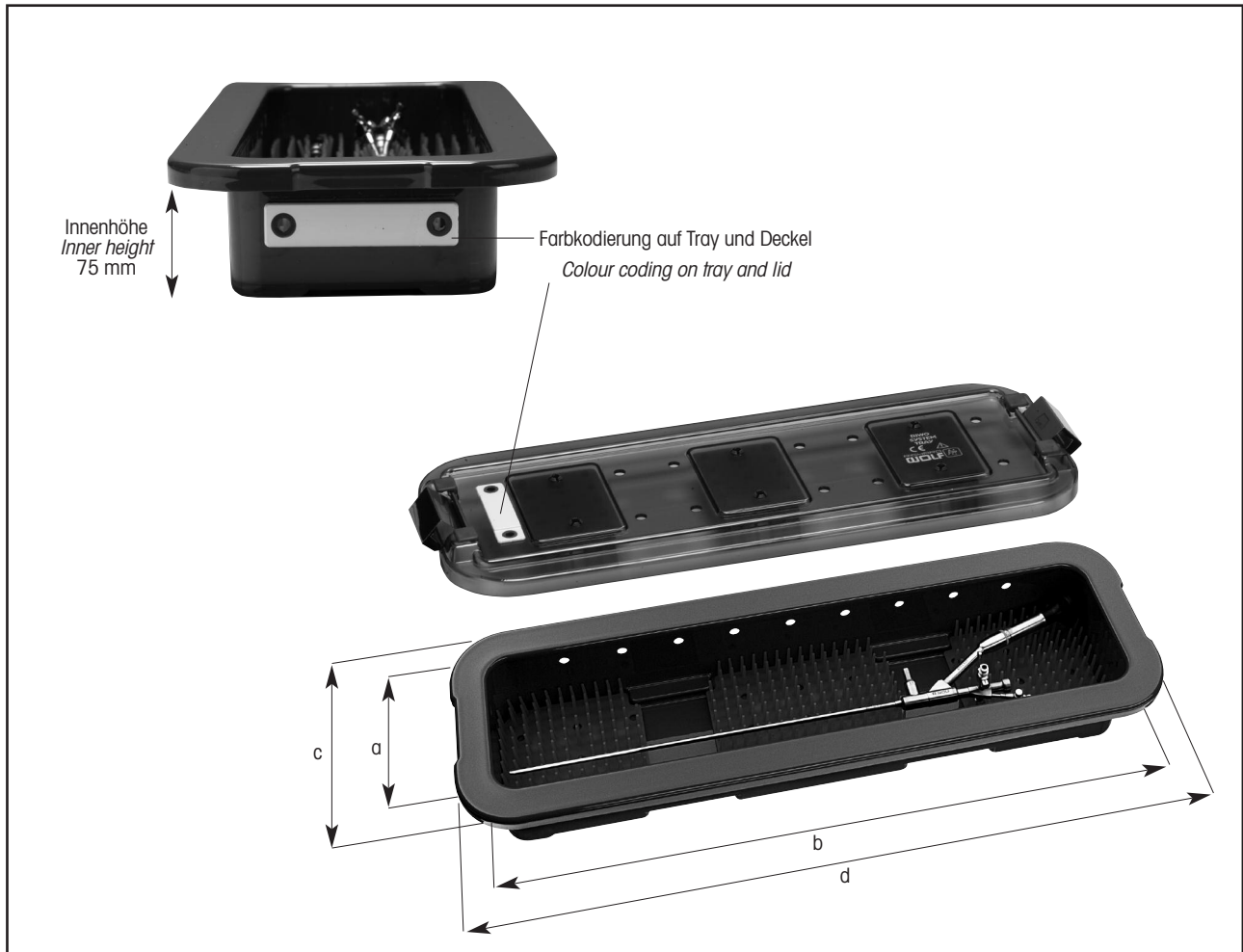

	passend für suitable for	Innenmaße / Inner dimensions		Außenmaße / Outer dimensions		Type / Type
		a Breite / Width mm	b Länge / Length mm	c Breite / Width mm	d Länge / Length mm	
RIWO-SYSTEM-TRAY universal einsetzbar in 2 Längen RIWO-SYSTEM-TRAY universal application in 2 lengths	z.B. / e.g. URS: 8702.523 / .533 8703.523 / .533 8968.421	120	500	186	566	38201.583
	z.B. / e.g. 8702.524 / .534 8703.524 / .534	120	700	186	766	38201.783

RIWO-SYSTEM-TRAY
for sterilization

RIWO-SYSTEM-TRAY
für die Sterilisation

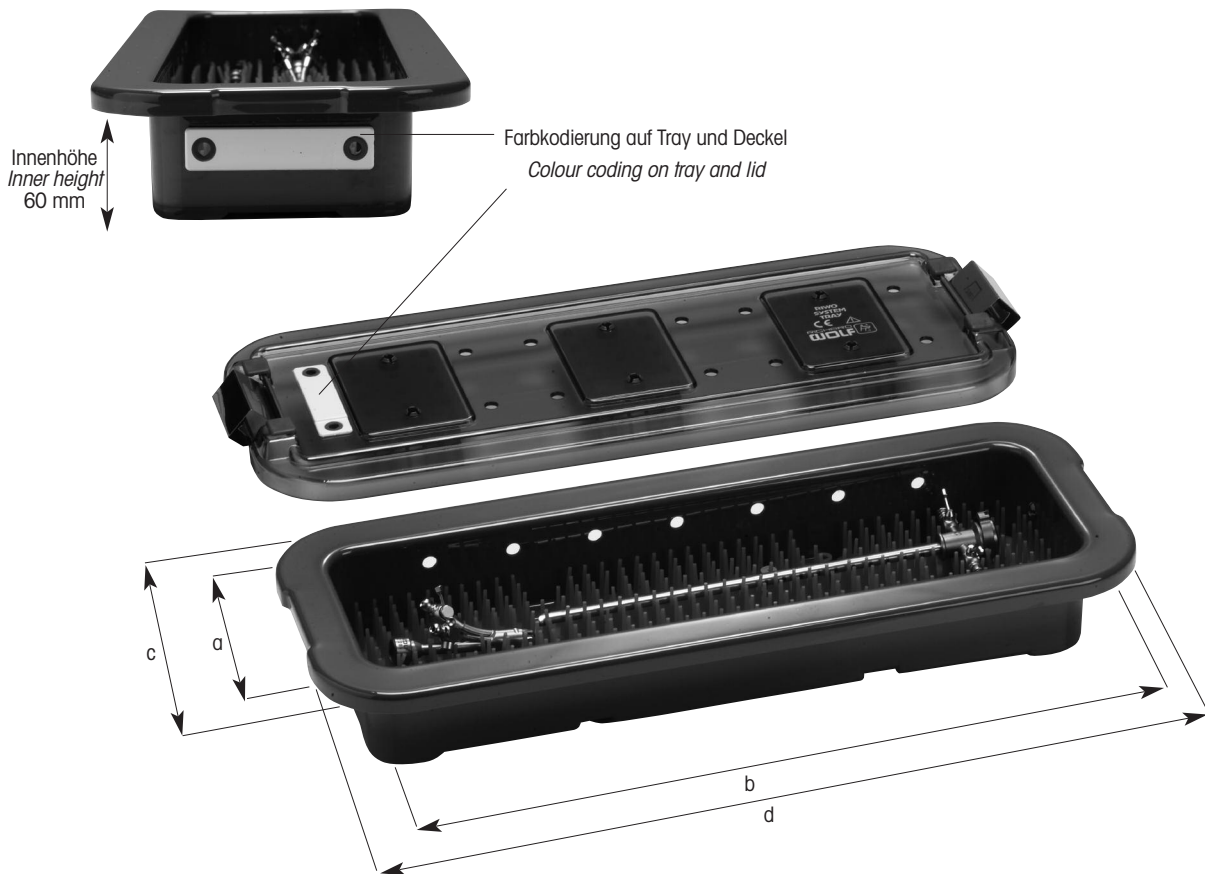

	Innenmaße / Inner dimensions		Außenmaße / Outer dimensions		Noppenmattenset / Peg mat set	Type / Type
	a Breite / Width mm	b Länge / Length mm	c Breite / Width mm	d Länge / Length mm		
RIWO-SYSTEM-TRAY universal einsetzbar in 5 Längen	120	300	186	366	38201.321	38201.382
	200	300	266	366	38201.322	38201.386
RIWO-SYSTEM-TRAY universal application in 5 lengths	120	400	186	466	38201.323	38201.482
	200	400	266	466	38201.324	38201.486
	120	500	186	566	38201.323	38201.582
	200	500	266	566	38201.324	38201.586
	120	600	186	666	-	38201.682
	200	600	266	666	38201.326	38201.686
	120	700	186	766	-	38201.782
	200	700	266	766	38201.326	38201.786

RIWO-SYSTEM-TRAY
for sterilization of telescopes

RIWO-SYSTEM-TRAY
für die Sterilisation von Optiken



1



*RIWO-TRAY on request.
Please specify type number of the telescope.*

RIWO-TRAY auf Anfrage.
Bitte Typen-Nr. der Optik angeben.



Protective Sterilisation Sleeve
for a maximum of 5 resection or vaporisation electrodes, or urethrotome knives,
outer Ø 20 mm, length 328 mm8428.901

Sterilisations-Schutzhülse
zur Aufnahme von max. 5 Resektions- oder Vaporisations-Elektroden, oder Urethrotommesser,
Außen-Ø 20 mm, Länge 328 mm8428.901

RIWO-CLEAN-RACK

for sterilization, transport and storage
for arthro forceps

RIWO-CLEAN-RACK

für Sterilisation, Transport und Lagerung
für Arthro-Zangen



1

- Passing instruments in the operating room**
 - simple and safe passing of instruments is ensured
- Transport**
 - securely held forceps are protected against damage
 - suitable for WOLF forceps 8487 / 8488 / 8489 / 8404 / 8403 / 8486
- Cleaning**
 - optimum cleaning with the instruments supported only at a few points
 - "rinsing shadows" avoided thanks to the diagonal arrangement of the instruments
 - handles and jaws of the forceps held open for efficient rinsing of the joint
- Sterilization**
 - sterilizable materials guarantee long service life
 - steam-sterilizable at 134° C
 - available in sterilization container with cover
- Storage**
 - instruments can be stored for up to six months

- Zureichung im OP**
 - einfaches und sicheres Zureichen gewährleistet
- Transport**
 - sicher gehaltene, fixierte Zangen sind vor Beschädigung geschützt
 - passend für WOLF-Arthro-Zangen der Typen 8487 / 8488 / 8489 / 8404 / 8403 / 8486
- Reinigung**
 - optimale Reinigung durch Punktauflage
 - durch schräge Anordnung der Arthro-Zangen werden Spülschatten vermieden
 - die Griff- und Maulteile der Arthro-Zangen werden offen gehalten - Gelenkspülung
- Sterilisation**
 - sterilisierbare Werkstoffe garantieren lange Lebensdauer
 - dampfsterilisierbar bei 134° C
 - lieferbar in Sterilisationsbehälter mit Deckel
- Lagerung**
 - bis max. 6 Monate möglich

RIWO-CLEAN-RACK,
basket for holding up to 15 forceps38 060.501
Dimensions (W x H x D): 395 x 105 x 195 mm

RIWO-CLEAN-RACK-UNIT
consisting of:
Container (38202.409) with cover (38202.494)
including basket (38060.501)38 060.001

RIWO-CLEAN-RACK,
Korb zur Aufnahme von maximal 15 Zangen38 060.501
Abmessungen (B x H x T): 395 x 105 x 195 mm

RIWO-CLEAN-RACK-UNIT
bestehend aus:
Behälter (38202.409) mit Deckel (38202.494)
inklusive Korb (38060.501)38 060.001

Disinfection
RIWO-BOX

Desinfektion
RIWO-BOX

2



Washing, disinfection, neutralisation

RIWO-BOX, the safe, complete system for processing contaminated instruments.

Simple and practical handling thanks to practice-oriented design guarantees safe and straightforward instrument processing.

RIWO-BOX incl. perforated basket and lid

outer dimensions: 552 x 200 x 165 mm

perforated basket inner dimensions: 432 x 150 x 100 mm

RIWO-BOX for washing used and contaminated instruments

not autoclavable6860.901

autoclavable8509.01

Nassentsorgung, Desinfektion, Neutralisation

RIWO-BOX, das sichere und komplette System zur Aufbereitung kontaminierter Instrumente.

Einfache und praktische Handhabung durch praxisorientiertes Design garantiert einen sicheren und reibungslosen Arbeitsablauf im Bereich der Instrumenten-Aufbereitung.

RIWO-BOX inkl. Siebkorb und Deckel

Außenmaße: 552 x 200 x 165 mm

Siebkorb-Innenmaße: 432 x 150 x 100 mm

RIWO-BOX zur Nassentsorgung von benutztem und kontaminiertem Instrumentarium

nicht dampfsterilisierbar6860.901

dampfsterilisierbar8509.01

Disinfection
RIWO-BOX

Desinfektion
RIWO-BOX

2



Washing, disinfection, neutralisation

RIWO-BOX, the safe, complete system for processing contaminated instruments.

Simple and practical handling thanks to practice-oriented design guarantees safe and straightforward instrument processing.

RIWO-BOX incl. perforated basket and lid

outer dimensions: 881 x 200 x 165 mm

perforated basket inner dimensions: 760 x 150 x 100 mm

RIWO-BOX for washing used and contaminated instruments

not autoclavable.....6860.911

Nassentsorgung, Desinfektion, Neutralisation

RIWO-BOX, das sichere und komplette System zur Aufbereitung kontaminierter Instrumente.

Einfache und praktische Handhabung durch praxisorientiertes Design garantiert einen sicheren und reibungslosen Arbeitsablauf im Bereich der Instrumenten-Aufbereitung.

RIWO-BOX inkl. Siebkorb und Deckel

Außenmaße: 881 x 200 x 165 mm

Siebkorb-Innenmaße: 760 x 150 x 100 mm

RIWO-BOX zur Nassentsorgung von benutztem und kontaminiertem Instrumentarium

nicht dampfsterilisierbar6860.911

Disinfection
RIWO-BOX

Desinfektion
RIWO-BOX

2



RIWO-BOX for disinfection

incl. lid

outer dimensions: 600 x 400 x 140 mm

inner dimensions: 548 x 348 x 100 mm509.81

RIWO-BOX zur Desinfektion

inkl. Deckel

Außenmaße: 600 x 400 x 140 mm

Innenmaße: 548 x 348 x 100 mm509.81

Water Jet Cleaning Pistol

Wasserstrahl-Reinigungspistole

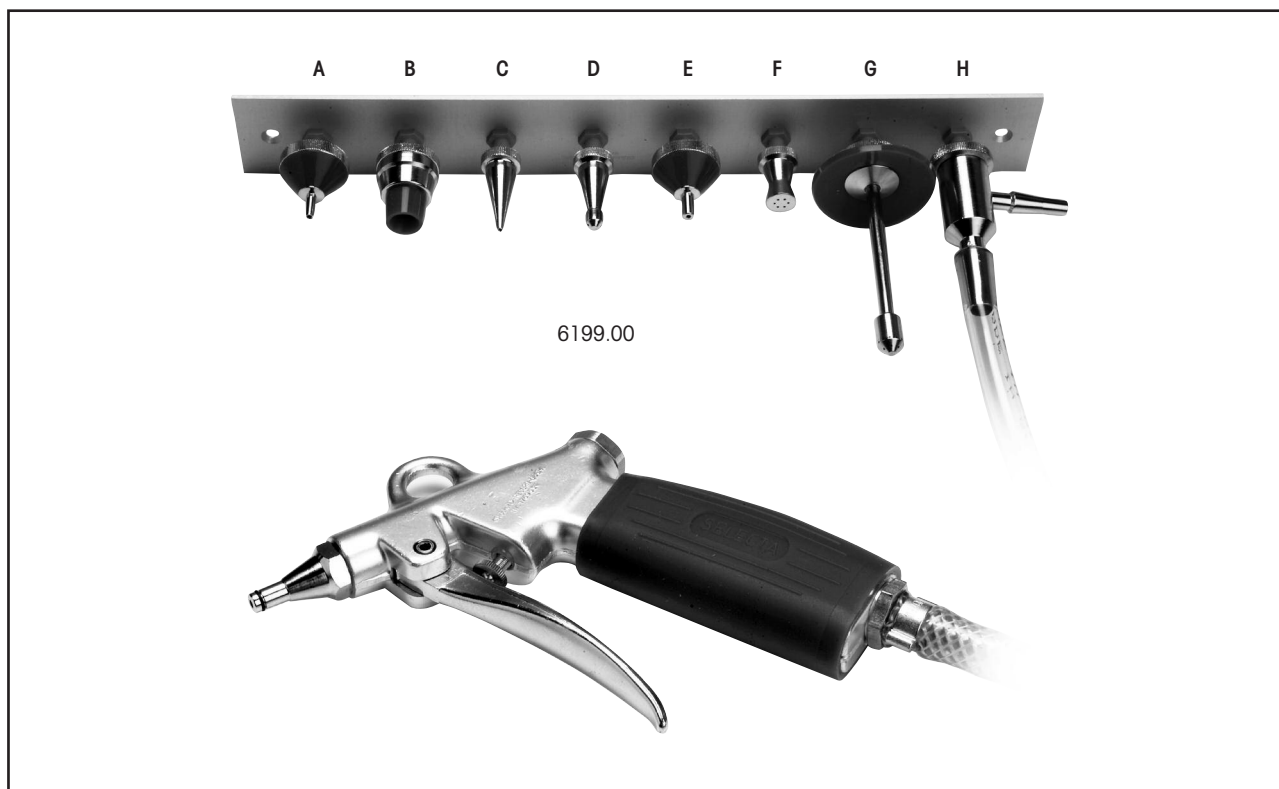

3

Water jet cleaning pistol for connection to water faucet with R-3/4" thread incl. attachments (A-H, see below) and holder6199.00

Wasserstrahl-Reinigungspistole zum Anschluss an Wasserleitungshahn mit R-3/4"-Gewinde inkl. Ansätze (A-H, siehe unten) und Halterung6199.00

The attachments are suitable for cleaning

Die Ansätze eignen sich zum Reinigen von

- A Sheaths and inserts, syringes, injection cannulas..... 15515.003
- B Sheaths, measuring and blood pipettes 15515.004
- C Catheters 15515.005
- D Drainage tubes 15515.006
- E Taps, cannulas and syringes 15515.007
- F Douche attachments..... 15515.009
- G Bottles..... 15515.008
- H Water jet pumps (with attachments also suitable for drying) 15515.010

- A Schäften und Einsätzen, Spritzen, Injektionskanülen..... 15515.003
- B Schäften, Mess- und Blutpipetten 15515.004
- C Kathetern 15515.005
- D Drainageschläuchen 15515.006
- E Hähnen, Kanülen und Spritzen 15515.007
- F Brauseansätzen 15515.009
- G Flaschen 15515.008
- H Wasserstrahlpumpen (mit Ansätzen auch zum Trocknen geeignet) 15515.010

Cleaning Accessories

Reinigungs-Zubehör

3

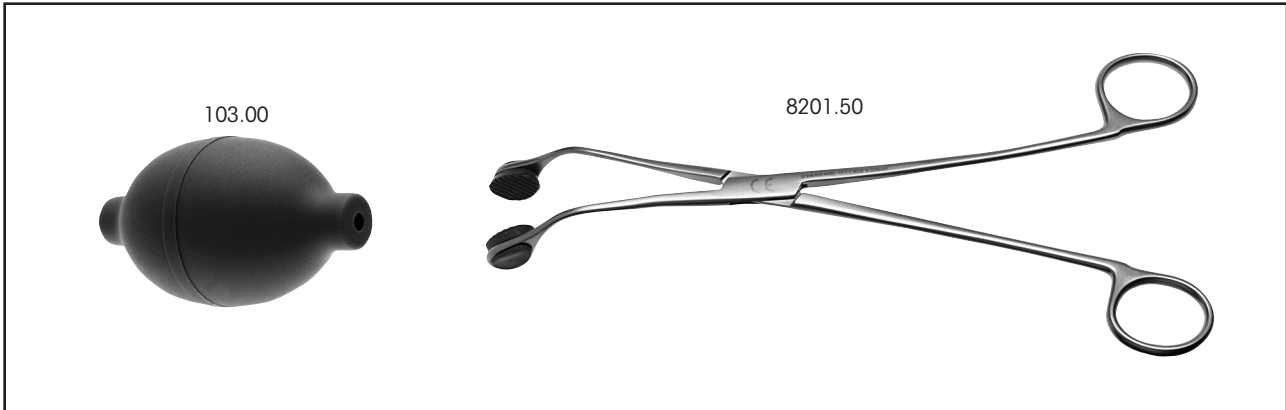

Hand bulb for blowing through channels 103.00

Druckball zum Durchblasen von Kanälen 103.00

Instrument grasping forceps, angled distal tips, with rubber jaws for gentle handling of instruments 8201.50

Instrumenten-Fasszange, distal abgewinkelt, mit Gummibacken zum schonenden Fassen von Instrumenten 8201.50

For machine processing and ultrasound

We recommend having both types on hand.

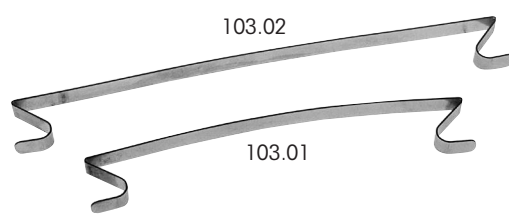

Für die maschinelle Aufbereitung und Ultraschall

Wir empfehlen Ihnen, beide Typen vorrätig zu haben.

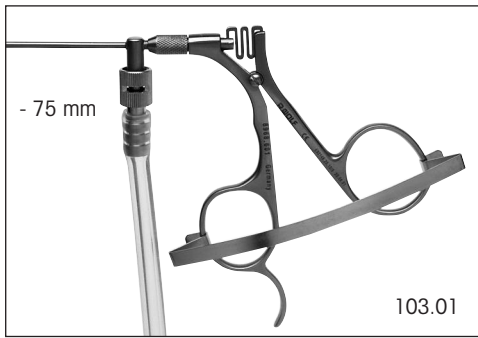

- 75 mm

103.01

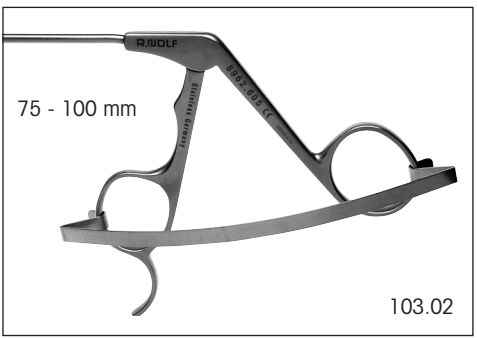

75 - 100 mm

103.02

Cleaning clamp, short
opening range up to 75 mm (pack of 10) 103.01

Reinigungsklammer, kurz
Spannbereich bis 75 mm (VE= 10 Stück) 103.01

Cleaning clamp, long
opening range up to 75 - 110 mm (pack of 10) 103.02

Reinigungsklammer, lang
Spannbereich bis 75-110 mm (VE= 10 Stück) 103.02

Adapters for Washing Units

Adaption an Spülmaschinen

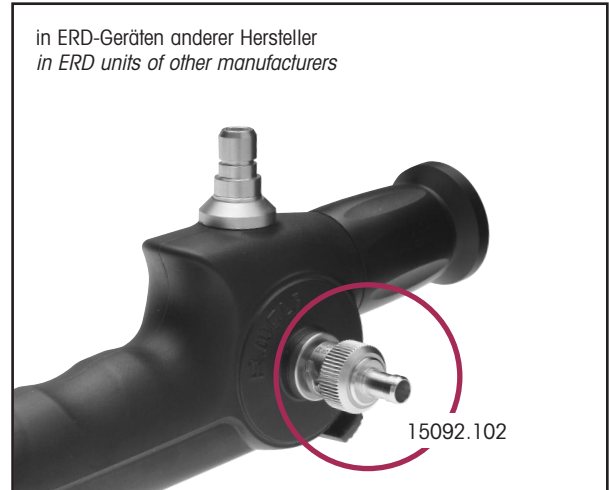
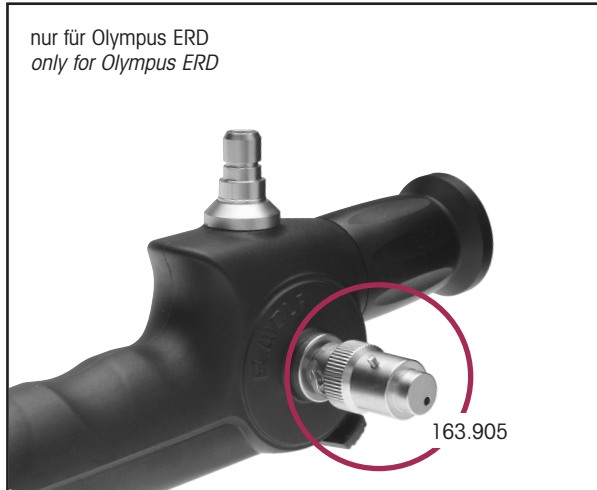

3

Adapter for leakage testing
in Olympus endoscope washer / disinfectant 163.905

Adapter for leakage testing
in endoscope washers / disinfectants
of other manufacturers 15092.102

Adapter für Dichtigkeitstest
in Olympus-ERD-Spülmaschinen 163.905

Adapter für Dichtigkeitstest
in ERD-Geräten
anderer Hersteller 15092.102

Adapters for Washing Units

Adaption an Spülmaschinen



3

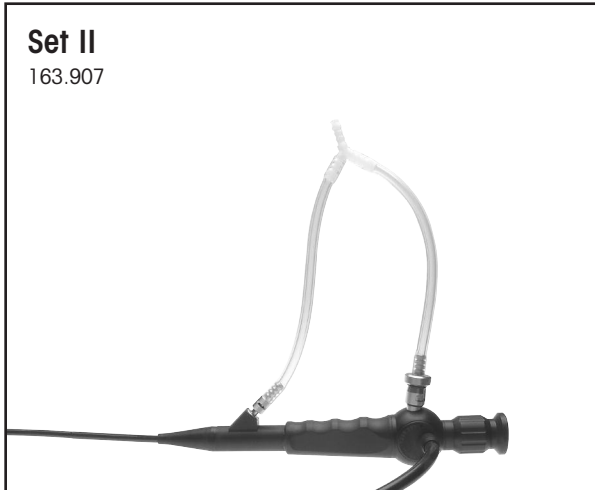

Set II
163.907

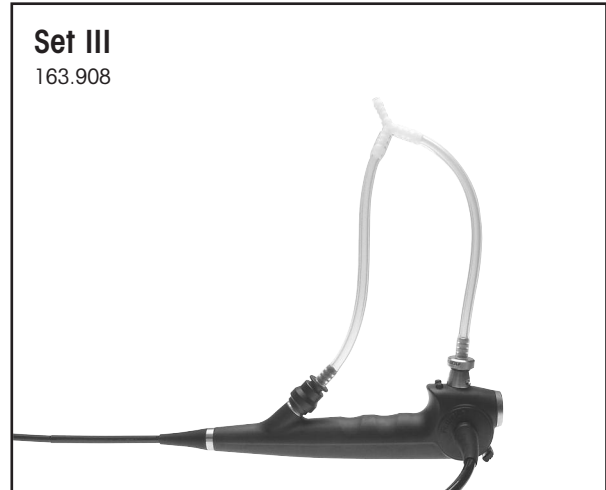

Set III
163.908

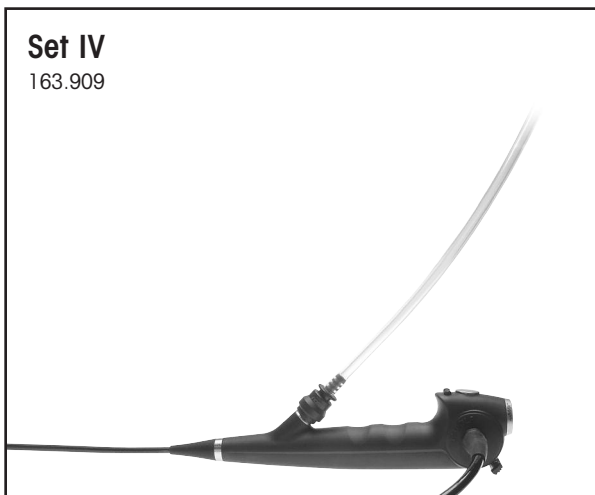

Set IV
163.909

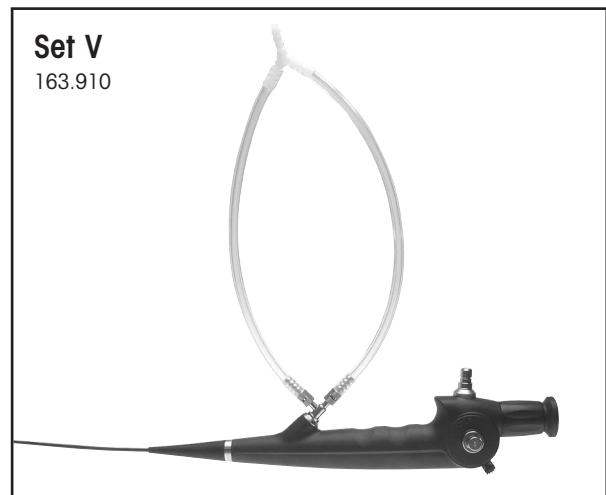

Set V
163.910

For machine cleaning of:

- Cleaning set II**
for flexible Bronchoscopes, DAFE bronchoscopes 163.907
- Cleaning set III**
for Video-urethro-cystoscopes, PDD Video-urethro-cystoscopes,
Video-bronchoscopes, DAFE video-bronchoscopes 163.908
- Cleaning set IV**
for Video-urethro-cystoscopes 163.909
- Cleaning set V**
with double luer lock tube connector
for flexible Fiber-uretero-renoscopes 163.910
- Luer lock tube connector**
for flexible Urethro-cystoscopes / Hysteroscopes,
Nasopharyngo-laryngoscopes 886.00

Für die maschinelle Aufbereitung:

- Spülset II**
für flexible Bronchoskope, DAFE Bronchoskope 163.907
- Spülset III**
für Video-Urethro-Cystoskope, PDD Video-Urethro-Cystoskope,
Video-Bronchoskope, DAFE Video-Bronchoskope 163.908
- Spülset IV**
für Video-Urethro-Cystoskope 163.909
- Spülset V**
mit Doppel-Luer-Lock-Schlauchteil
für flexible Fiber-Uretero-Renoskope 163.910
- Luer-Lock-Schlauchteil**
für flexible Urethro-Cystoskope / Hysteroskope,
Nasopharyngo-Laryngoskope 886.00

Cleaning Brushes

Reinigungsbürsten

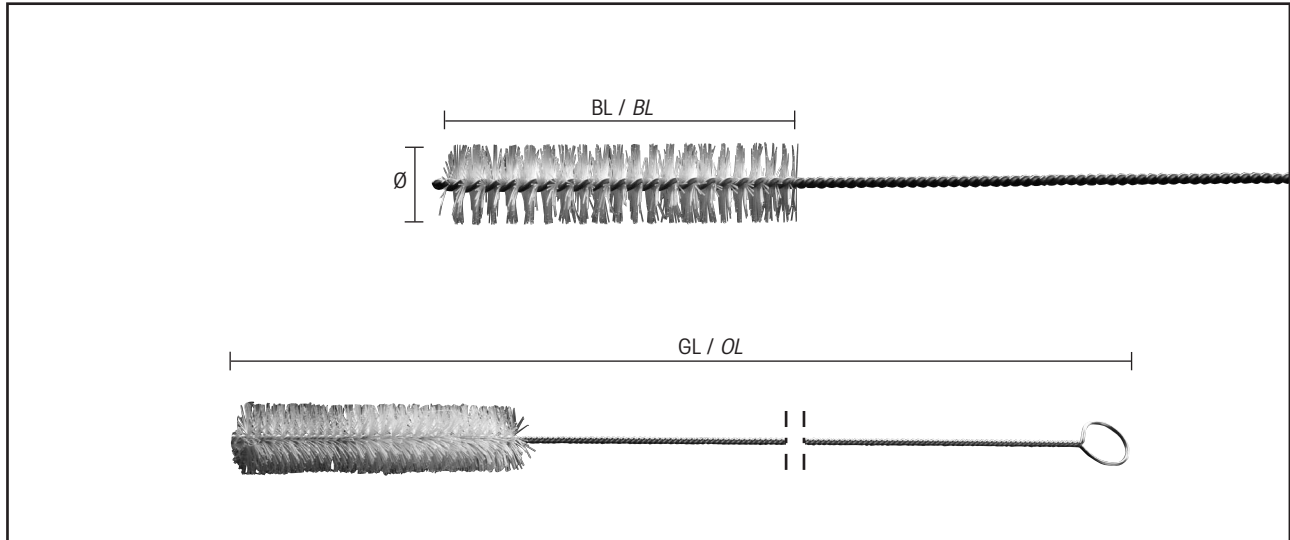

3

Ø mm	Bürstenlänge BL / Brush length BL mm	Gesamtlänge GL / Overall length OL mm	Einsatzgebiet Beispiel / Example of areas of application	Typen / Types
11	100	360	Schäfte und Trokarhülsen / Sheaths and trocar sleeves	6.01
5	50	375	Optikführungsrohre an Einsätzen und Transporteuren / Telescope guide tube for inserts and transporters	6.03
2	50	400	Elektrodenführungsrohre an Transporteuren / Electrode guide tubes for transporters	6.04
3	50	365		6.041
2	50	240		6.045
5	60	515	Operations-Laparoskope / Operating laparoscope	6.05
5	50	240	Schwachkalibrige Schäfte (24 cm lang) / Small-calibre sheaths (24 cm long)	6.06
1.8	55	610	Uretero-Renoskope Uretero-Renoscopy	6.061
13	80	340	Kinder Rektoskop-Tuben / Paediatric rectoscope tubes	6.07
19	80	440	Rektoskop-Tuben / Rectoscope tubes	6.08
9	80	405	Oesophagoskope-Tuben, je nach Abmessung Oesophagoscope tubes, depending on dimensions	6.09
12	100	700		6.12
20	100	620		6.20

Cleaning Brushes

Reinigungsbürsten

3

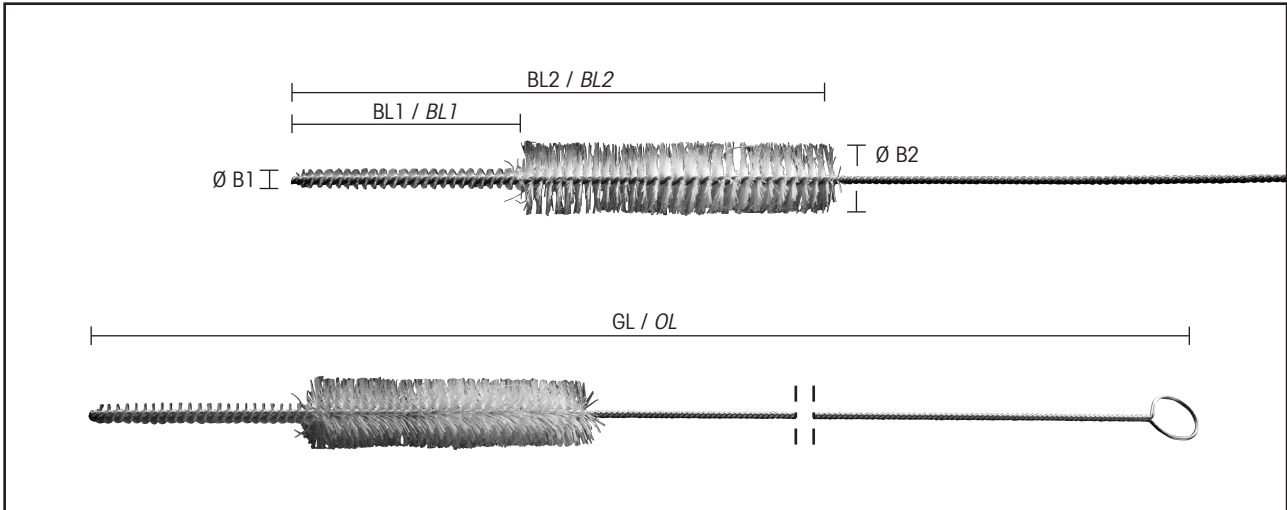

Ø B1 mm	Ø B2 mm	Bürstenlänge BL1 / Brush length BL1 mm	Bürstenlänge BL2 / Brush length BL2 mm	Gesamtlänge GL / Overall length OL mm	Typen / Types
3	5	40	100	250	6.011
3	13	40	100	250	6.012

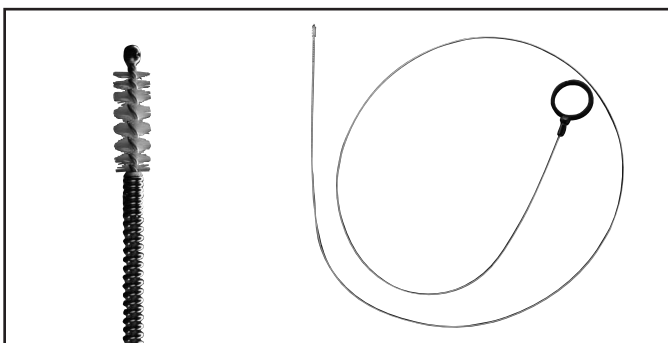

Ø mm	Bürstenlänge Brush length BL / BL mm	Arbeitslänge Working length NL / WL mm	Gesamtlänge Overall length GL / OL mm	Typen / Types
3	8	--	1000	7264.691
2.5	10	--	1000	7321.911
5	10	175	285	7268.691

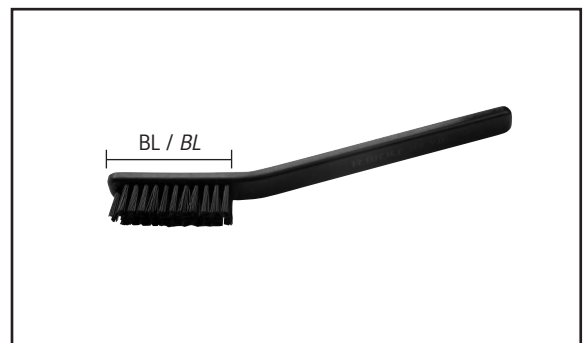

	Bürstenlänge BL / Brush length BL mm	Type / Type
Reinigungsbürste, dampfsterilisierbar Cleaning brush, autoclavable	42	86.90



4

Cleanser for removing surface oxidation 100.00

Putzmittel zum Entfernen von Oberflächen-Oxidationen 100.00

Dropper bottle for oil (27.5 ml)
for trocar sleeves, resectoscopes, taps, Albarran levers,
flexible and rigid forceps 200.532

Tropfflasche Öl (27,5 ml)
für Trocarhülsen, Resektoskope, Hähne, Albarranhebel,
flexible und starre Zangen 200.532

Oil dispenser (without oil) 200.00

Sparöler (ohne Füllung) 200.00

*Anti Fogging Agents
for endoscopic telescopes*

Antibeschlagmittel
für endoskopische Optiken



5

Anti fogging agent, sterile
disposable pipette, portioned, alcohol-free, silicone-free,
wax-free (pack of 10) 102.02

Anti fogging agent "Ultrastop"
sterile filling, contains alcohol,
pierce-cap bottle, 30 ml 102.01

Antibeschlagmittel, steril
Einmalpipette, portionsweise einsetzbar, alkoholfrei, silikonfrei,
waxfrei (VE = 10 Stück) 102.02

Antibeschlagmittel "Ultrastop"
sterile Abfüllung, alkoholisch,
Durchstichflasche, 30 ml 102.01

Accessories Rubber Seals

Zubehör Gummidichtungen

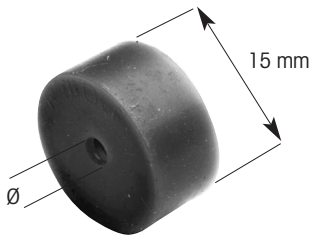
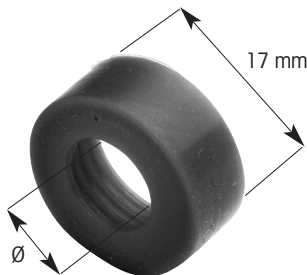
	Durchlass Capacity (\emptyset) mm	Farbe Colour	Type / Type
Dichtungskappe, klein, ohne Bohrung, 10 Stück <i>Sealing cap, small, blind, pack of 10</i>	-	rotorange / dark orange	89.20
Dichtungskappe, klein, 10 Stück <i>Sealing cap, small, pack of 10</i> 	< 2.4	schwarz / black	89.00
	2.4 - 3.4	rot / red	89.01
	3.4 - 5.1	blau / blue	89.02
	5.1 - 6.0	grau / grey	89.03
	6.0 - 7.0	braun / brown	89.04
	7.0 - 8.0	gelb / yellow	89.05
	8.5	grün / green	89.06
	9.0 - 9.5	schwarz / black	89.07
	5.0	blau / blue	90.001
	Dichtungskappe, groß, ohne Bohrung, 10 Stück <i>Sealing cap, large, blind, pack of 10</i>	-	rotorange / dark orange
Dichtungskappe, groß, 10 Stück <i>Sealing cap, large, pack of 10</i> 	9.5 - 10.1	rot / red	89.08
	> 10.1	blau / blue	89.09
	13.0 - 13.8	rot / red	89.10
	10.0	gelb / yellow	90.011
	4 - 6	rot / red	89.141
	7.5 - 8.5	blau / blue	89.161
	7.0	braun / brown	89.171
Ersatz-Dichtungskappe, groß, 10 Stück <i>Spare sealing cap, large, pack of 10</i>			

Accessories
Rubber Seals / Rubber Caps

Zubehör
Gummidichtungen / Gummikappen

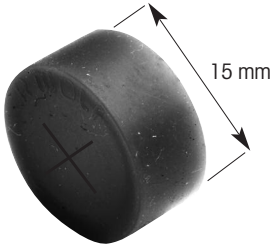
	Farbe Colour	Type / Type
<p>Dichtungskappe mit Kreuzschlitz, für Trokarhülse mit Gewindeschaff, 10 Stück Cross-head seal cap, for trocar sleeves with thread, pack of 10</p> 	rotorange / dark orange	89.90

6

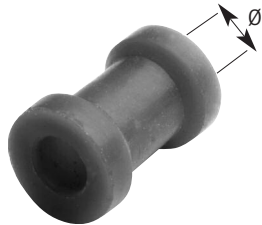
	Durchlass Capacity (Ø) mm	Farbe Colour	Type / Type
<p>Gummikappe "RIWO", ohne Bohrung, 10 Stück Rubber cap "RIWO", blind, pack of 10</p>	-	rotorange / dark orange	88.00
<p>Gummikappe "RIWO", 10 Stück Rubber cap "RIWO", pack of 10</p> 	0.5	rot / red	88.005
	0.8	rotorange / dark orange	88.01
	1.4	blau / blue	88.02
	2.4	schwarz / black	88.03
<p>Gummikappe "RIWO", für 5-mm-Instrumente, 10 Stück Rubber cap "RIWO", for 5 mm instruments, pack of 10</p>	4.0	grün / green	88.04

	Farbe Colour	Type / Type
<p>Gummikappe für Hysteroskop, verlängert (1 Stück) Rubber cap for hysteroscope, extended (pack of 1)</p> 	rotorange / dark orange	18.01

Sterile Water Conditioning

Sterilwasser-Aufbereitung



Der Name "R.WOLF" steht seit vielen Jahren für die Entwicklung von Sterilwasser-Anlagen zur wirtschaftlichen und umweltfreundlichen Aufbereitung von steriler Spüllösung für den urologischen Einsatz.

- Wiederverwendbar, dampfsterilisierbar
 - dadurch hohe Wirtschaftlichkeit
 - umweltfreundlich
- Keine retrograde Kontamination durch Keimschranke und Rückschlagventil in der Entnahme-Garnitur
- Geschlossenes Filtersystem
 - dadurch sichere hygienische Wasser-Filtration
- Sterilwasser-Filter mit einer Porengröße von 0,2 µm
- Höhenverstellbare Ausführungen zur Spüldruckregulierung
- Kein vorbehandeltes Wasser erforderlich (Trinkwasser nach TwVo)

For many years, the name "R.WOLF" has stood for the development of sterile water filter units for economic and environmentally friendly processing of sterile irrigation solutions for urology.

- Re-usable, autoclavable*
 - *for greater economy*
 - *environmentally friendly*
- No retrograde contamination by germ barrier and back pressure valve in the outlet system*
- Closed filter system*
 - *for safe, hygienic water filtering*
- Sterile water filter with a pore size of 0.2 µm*
- Height-adjustable models for regulating irrigation pressure*
- Pre-treated water unnecessary (normal drinking water)*

Sterile Water Filter Unit
700 ml

Sterilwasser-Filteranlage
700 ml



Sterilwasser-Filteranlage 700 ml

bestehend aus:

1 feststehende, verchromte Deckensäule mit Schnellkupplung für Raumhöhe bis 250 cm, 1 Deckenrosette, 1 Irrigator-Einheit (6244.70), 2 Entnahme-Garnituren (6346.00), 3 Filterpatronen (1 x 33 100.003)

bei verlegten Leitungen (Beschreibung siehe Rückseite)

unter Putz6244.10
auf Putz6244.11
in abgehängter Decke6244.12

bei Raumhöhen über 250 cm:

Deckensäulen-Verlängerung

je weitere angefangene 10 cm6244.99

Sterile water filter unit 700 ml

comprising:

1 fixed chromium-plated column with snap-on connector for rooms up to 250 cm high, 1 ceiling rosette, 1 irrigator unit (6244.70), 2 outlet sets (6346.00), 3 filter cartridges (1 x 33 100.003)

for pipes (description see overleaf)

in the ceiling6244.10
on the ceiling6244.11
in a false ceiling6244.12

for rooms higher than 250 cm:

Ceiling column extension

for each further 10 cm6244.99



zur Regulierung und optischer Kontrolle der Wassertemperatur:

Aufputz-Thermostatbatterie 1/2"

mit Absperrhahn und Thermometer6812.507

for controlling and indicating the water temperature:

Surface-type thermostat battery 1/2"

with stop tap and thermometer6812.507

Sterile Water Filter Unit
700 ml

Sterilwasser-Filteranlage
700 ml

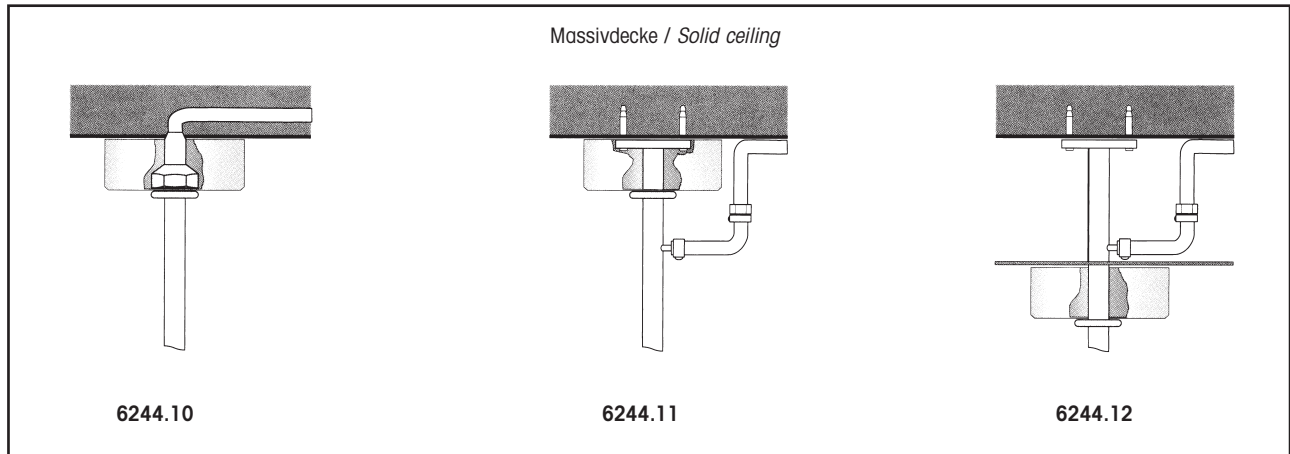

All sterile water filter units are designed for rooms 250 cm high. If the room is higher, an extension is required for the rigid ceiling column (6244.99 every 10 cm).

Please specify the exact dimensions as follows:

For 6244.10 and 6244.11:

the distance from the top surface of the finished floor to the surface of the solid ceiling

additional for 6244.12:

the distance from the top surface of the finished floor to the surface of the false ceiling

We will be happy to send you detailed installation plans.

Alle Sterilwasser-Filteranlagen sind für eine Raumhöhe von 250 cm ausgelegt. Bei höheren Räumen wird eine Verlängerung der starren Deckensäule erforderlich (6244.99 je 10 cm).

Bitte geben Sie grundsätzlich das genaue Maß an von:

Für 6244.10 und 6244.11:

Oberkante fertiger Fußboden bis Unterkante Massivdecke

zusätzlich für 6244.12:

Oberkante fertiger Fußboden bis Unterkante abgehängte Decke

Fordern Sie unsere ausführlichen Installationspläne an.